

Chapter I

Introduction

A note on the use of these Powerpoint slides:

We're making these slides freely available to all (faculty, students, readers). They're in PowerPoint form so you see the animations; and can add, modify, and delete slides (including this one) and slide content to suit your needs. They obviously represent a *lot* of work on our part. In return for use, we only ask the following:

- If you use these slides (e.g., in a class) that you mention their source (after all, we'd like people to use our book!)
- If you post any slides on a www site, that you note that they are adapted from (or perhaps identical to) our slides, and note our copyright of this material.

Thanks and enjoy! JFK/KWR

©All material copyright 1996-2016
J.F Kurose and K.W. Ross, All Rights Reserved

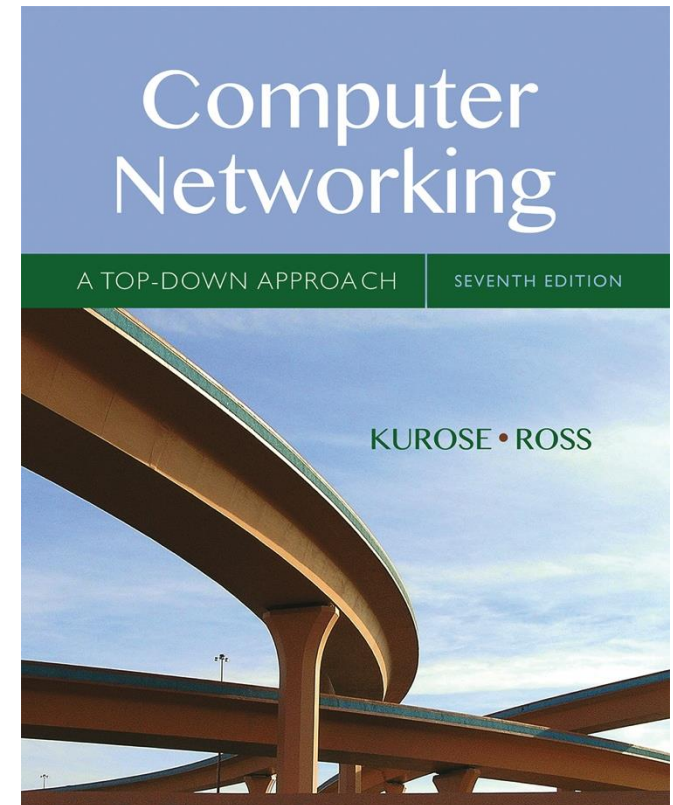

Computer Networking: A Top Down Approach

7th edition

Jim Kurose, Keith Ross

Pearson/Addison Wesley

April 2016

Chapter 1: introduction

our goal:

- get “feel” and terminology
- more depth, detail *later* in course
- approach:
 - use Internet as example

overview:

- what’s the Internet?
- what’s a protocol?
- network edge; hosts, access net, physical media
- network core: packet/circuit switching, Internet structure
- performance: loss, delay, throughput
- security
- protocol layers, service models
- history

Chapter 1: roadmap

1.1 *what is the Internet?*

1.2 network edge

- end systems, access networks, links

1.3 network core

- packet switching, circuit switching, network structure

1.4 delay, loss, throughput in networks

1.5 protocol layers, service models

1.6 networks under attack: security

1.7 history

What's the Internet: "nuts and bolts" view



- billions of connected computing devices:
 - hosts* = *end systems*
 - running *network apps*

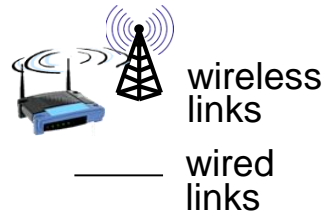

- communication links*
 - fiber, copper, radio, satellite
 - transmission rate: *bandwidth*



- packet switches*: forward packets (chunks of data)
 - routers* and *switches*

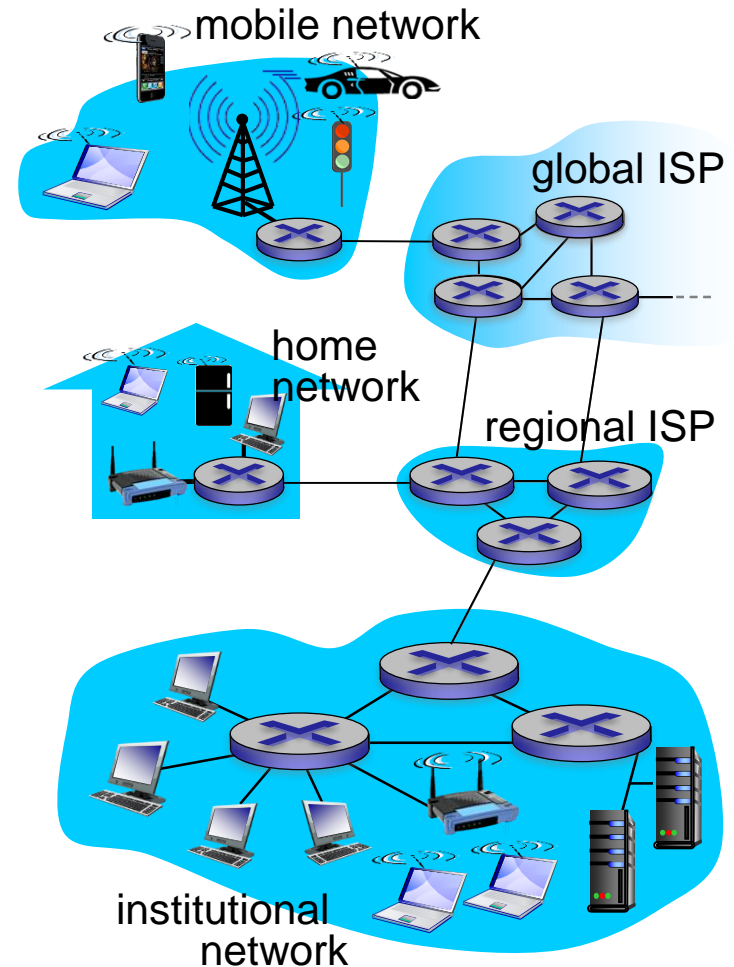

“Fun” Internet-connected devices



IP picture frame
<http://www.ceiva.com/>



Web-enabled toaster +
weather forecaster



Tweet-a-watt:
monitor energy use



Internet
refrigerator



Slingbox: watch,
control cable TV remotely



sensorized,
bed
mattress



Internet phones

What's the Internet: "nuts and bolts" view

- **Internet: "network of networks"**
 - Interconnected ISPs
- **protocols** control sending, receiving of messages
 - e.g., TCP, IP, HTTP, Skype, 802.11
- **Internet standards**
 - RFC: Request for comments
 - IETF: Internet Engineering Task Force

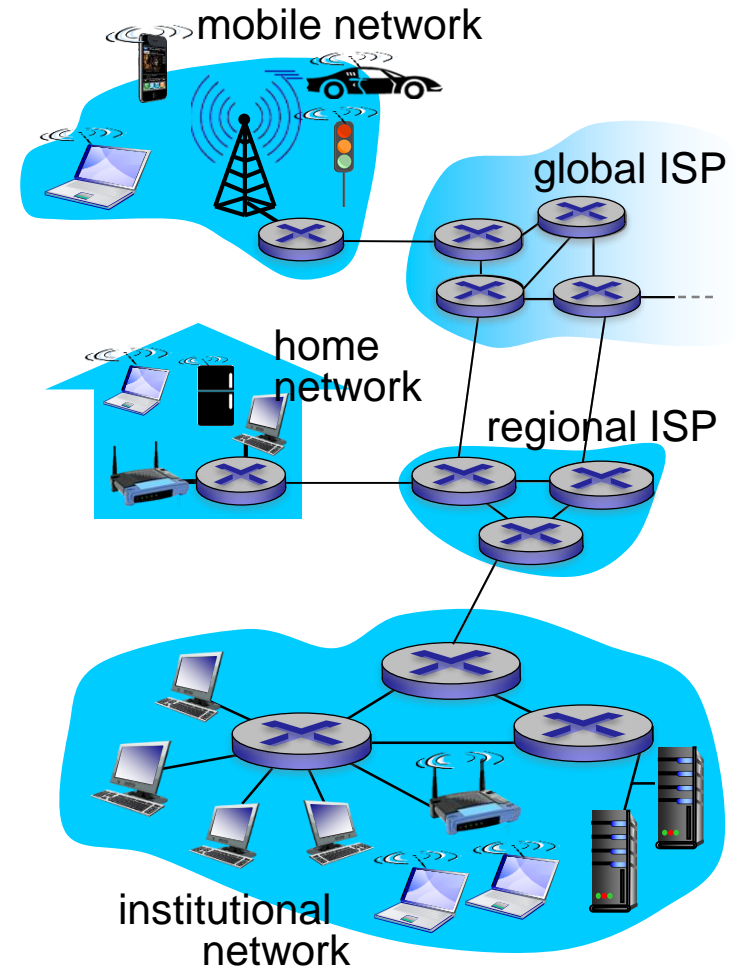

What's the Internet: a service view

- *infrastructure that provides services to applications:*
 - Web, VoIP, email, games, e-commerce, social nets, ...
- *provides programming interface to apps*
 - hooks that allow sending and receiving app programs to “connect” to Internet
 - provides service options, analogous to postal service

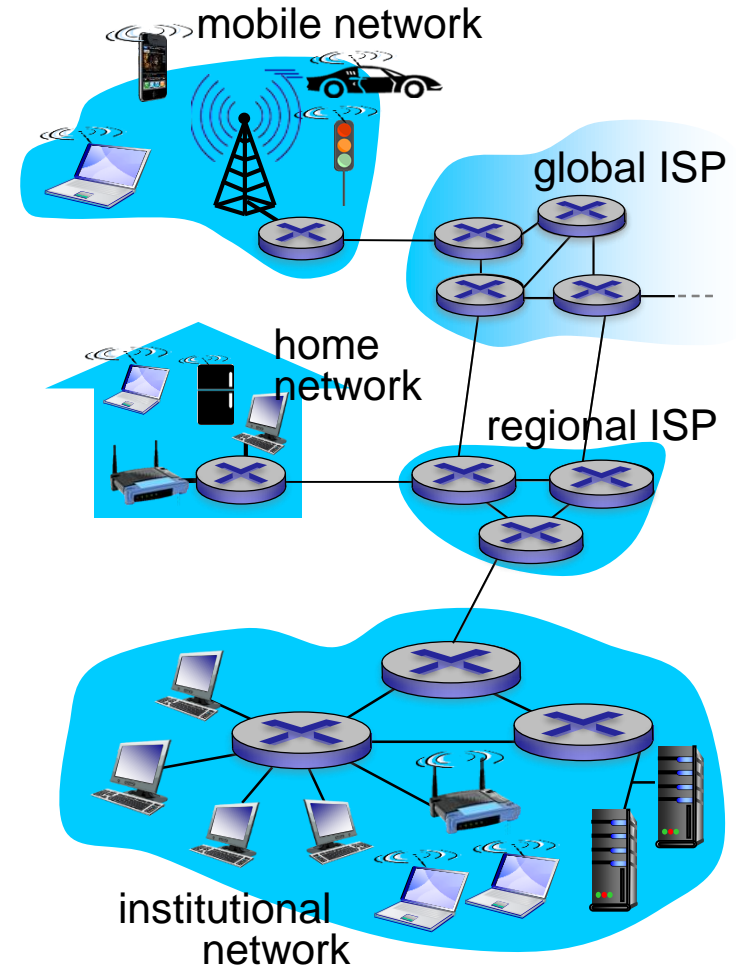

What's a protocol?

human protocols:

- “what's the time?”
- “I have a question”
- introductions

... specific messages sent

... specific actions taken
when messages received,
or other events

network protocols:

- machines rather than humans
- all communication activity in Internet governed by protocols

protocols define format, order of messages sent and received among network entities, and actions taken on message transmission, receipt

What's a protocol?

a human protocol and a computer network protocol:

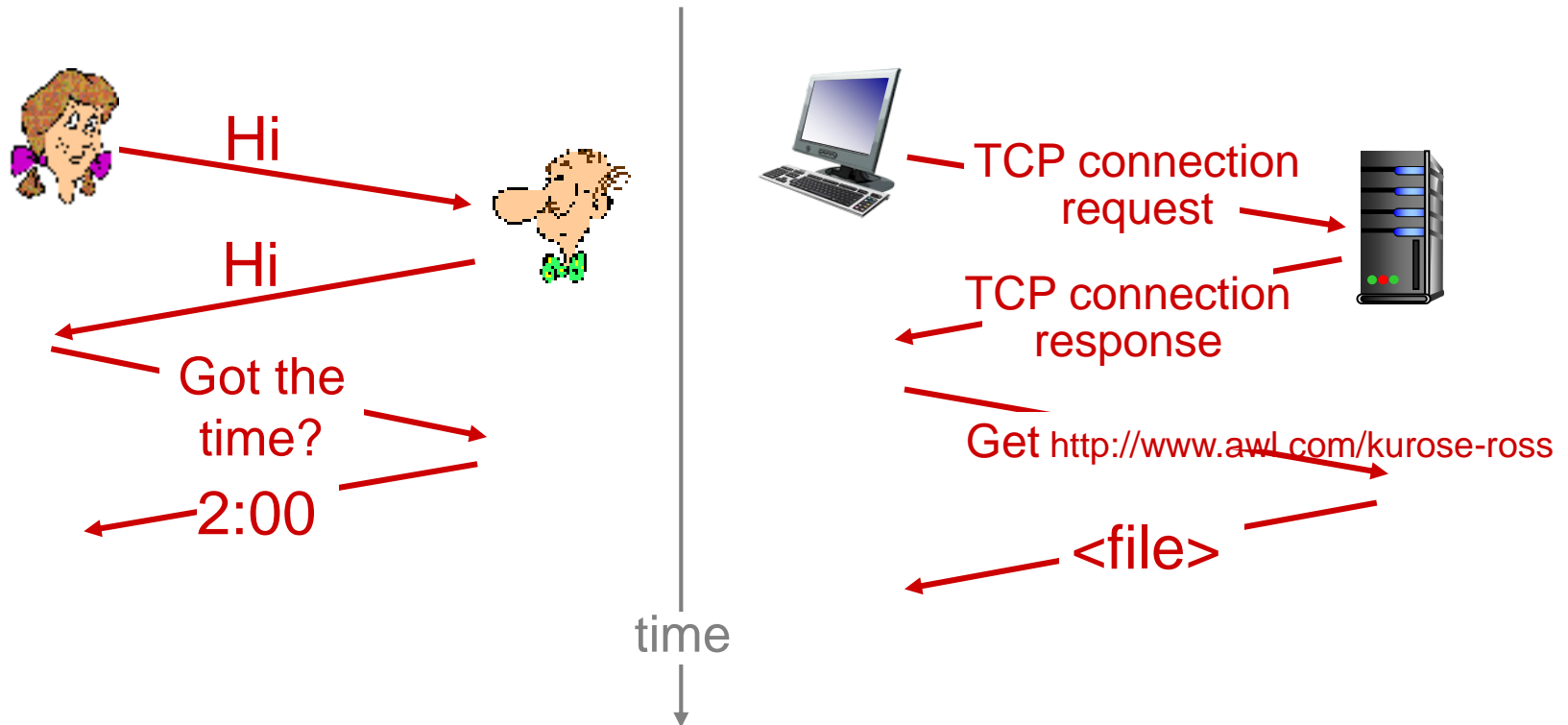

Q: other human protocols?

Chapter 1: roadmap

1.1 what is the Internet?

1.2 network edge

- end systems, access networks, links

1.3 network core

- packet switching, circuit switching, network structure

1.4 delay, loss, throughput in networks

1.5 protocol layers, service models

1.6 networks under attack: security

1.7 history

A closer look at network structure:

- **network edge:**
 - hosts: clients and servers
 - servers often in data centers
- **access networks, physical media:** wired, wireless communication links
- **network core:**
 - interconnected routers
 - network of networks

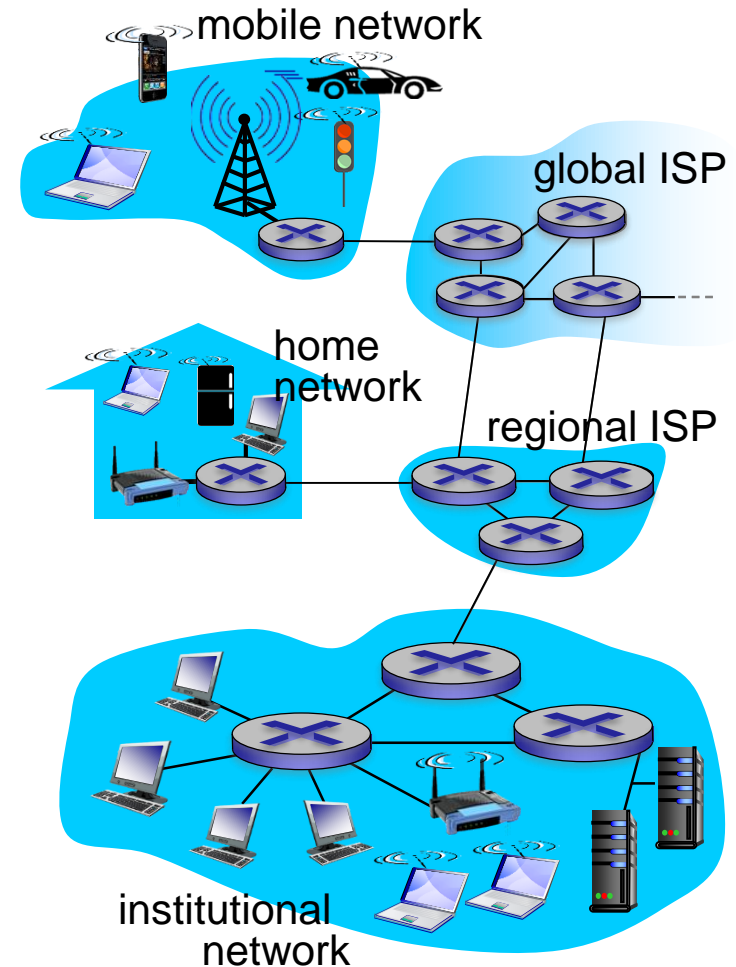

Access networks and physical media

Q: How to connect end systems to edge router?

- residential access nets
- institutional access networks (school, company)
- mobile access networks

keep in mind:

- bandwidth (bits per second) of access network?
- shared or dedicated?

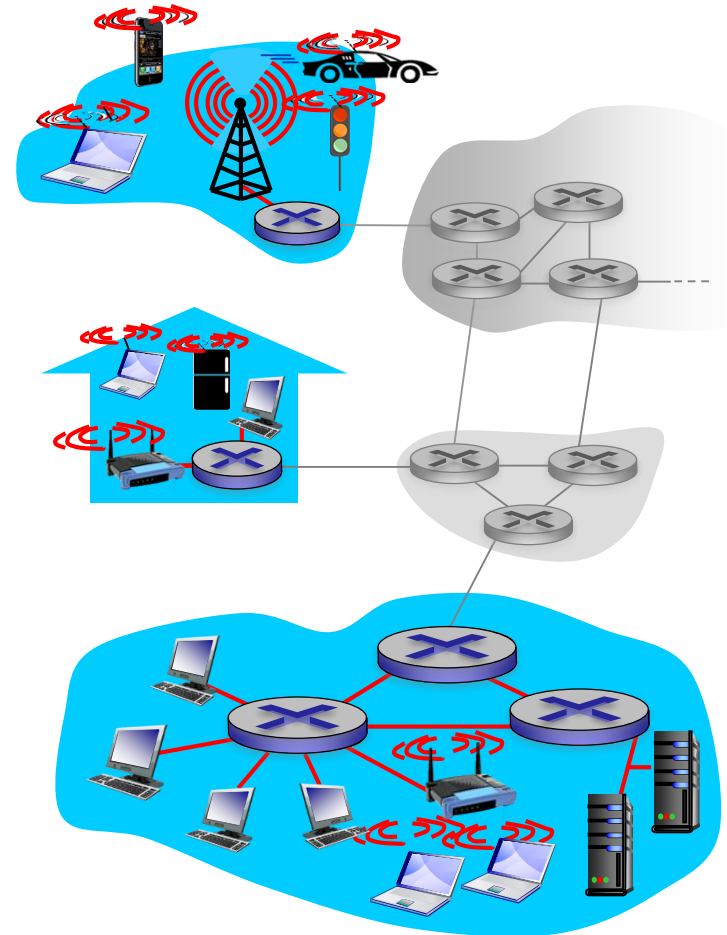

Access network: digital subscriber line (DSL)

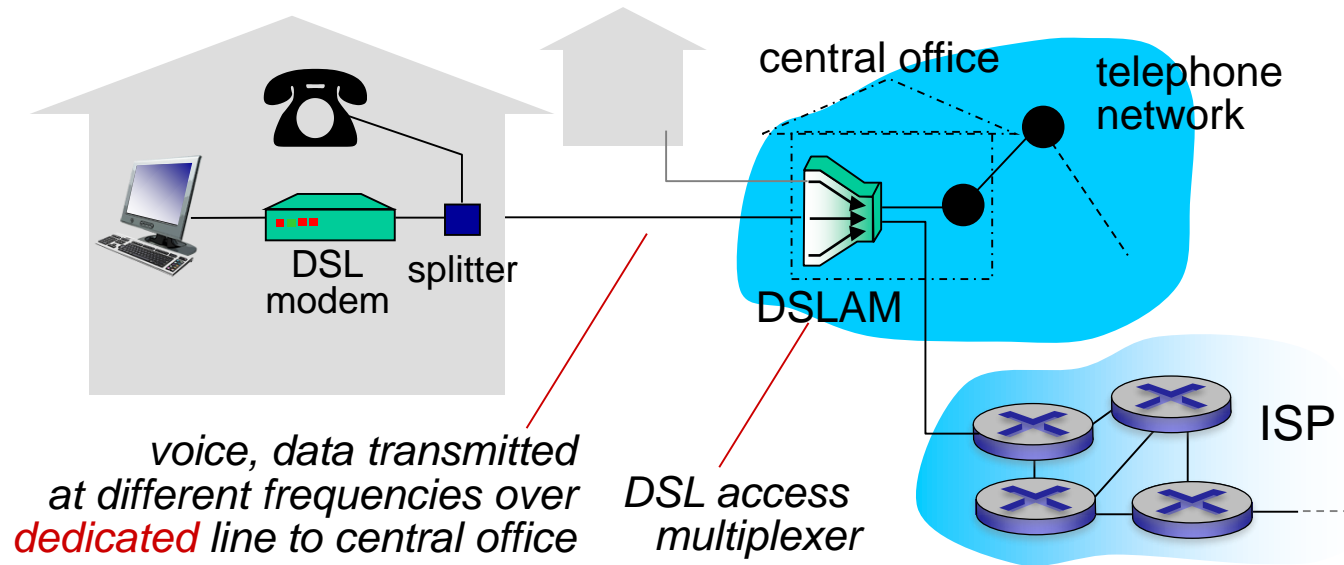

- use *existing* telephone line to central office DSLAM
 - data over DSL phone line goes to Internet
 - voice over DSL phone line goes to telephone net
- < 2.5 Mbps upstream transmission rate (typically < 1 Mbps)
- < 24 Mbps downstream transmission rate (typically < 10 Mbps)

Access network: cable network

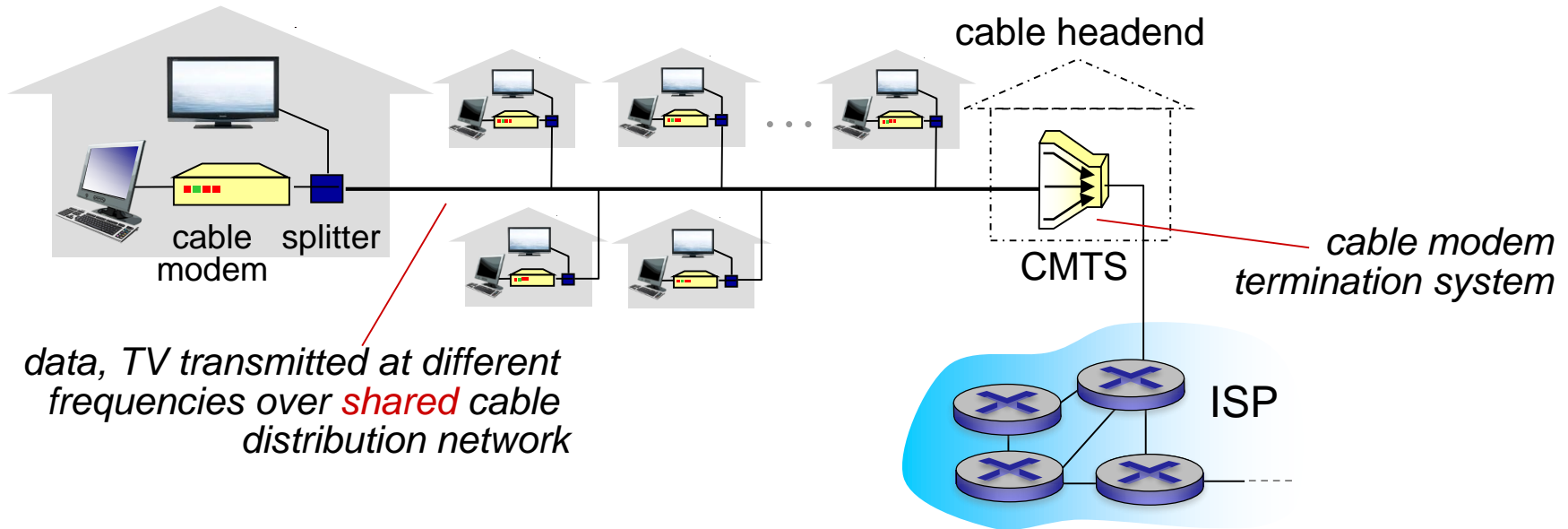

- **HFC: hybrid fiber coax**
 - asymmetric: up to 30Mbps downstream transmission rate, 2 Mbps upstream transmission rate
- **network** of cable, fiber attaches homes to ISP router
 - homes *share access network* to cable headend
 - unlike DSL, which has dedicated access to central office

Access network: home network

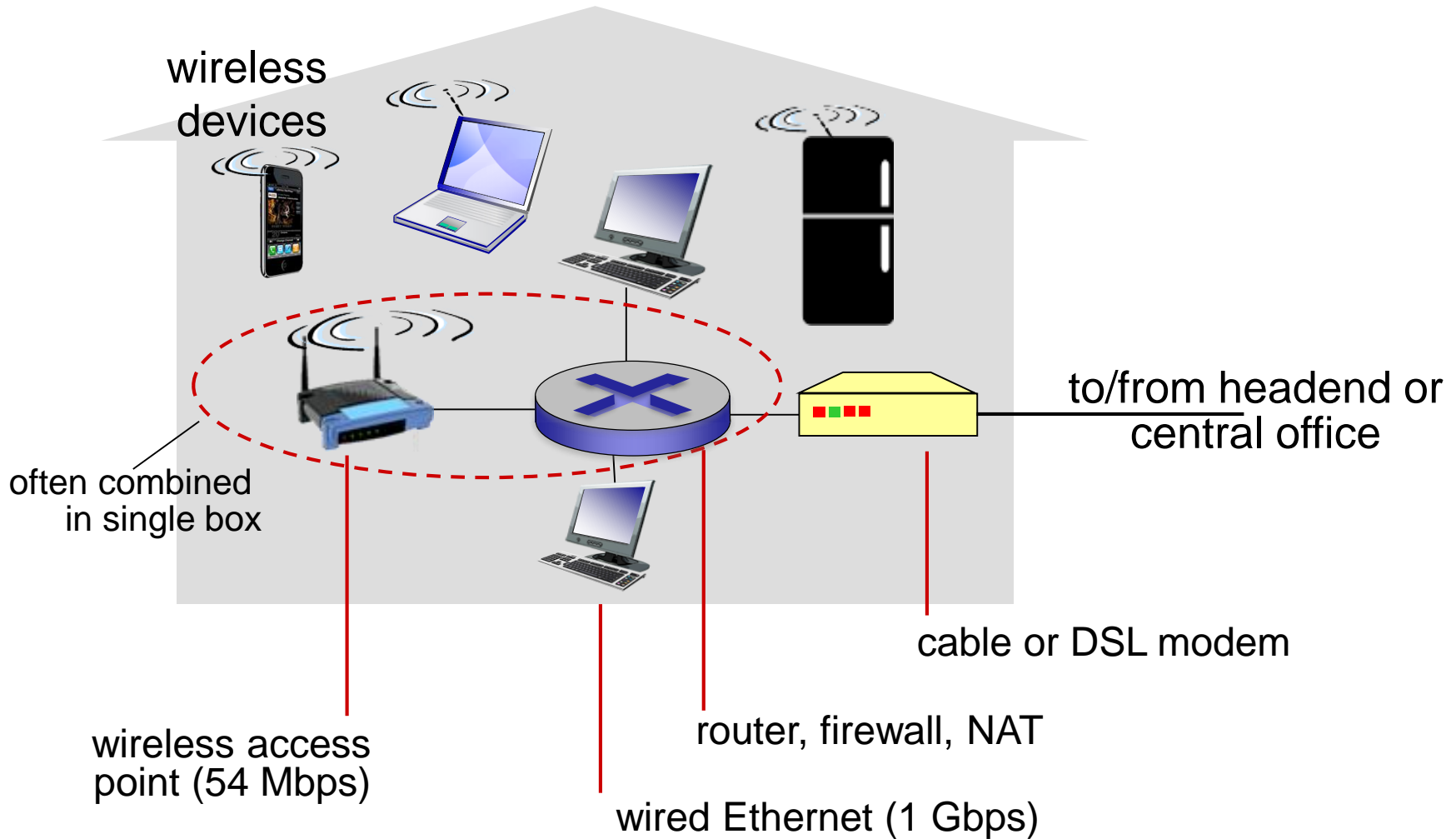

Enterprise access networks (Ethernet)

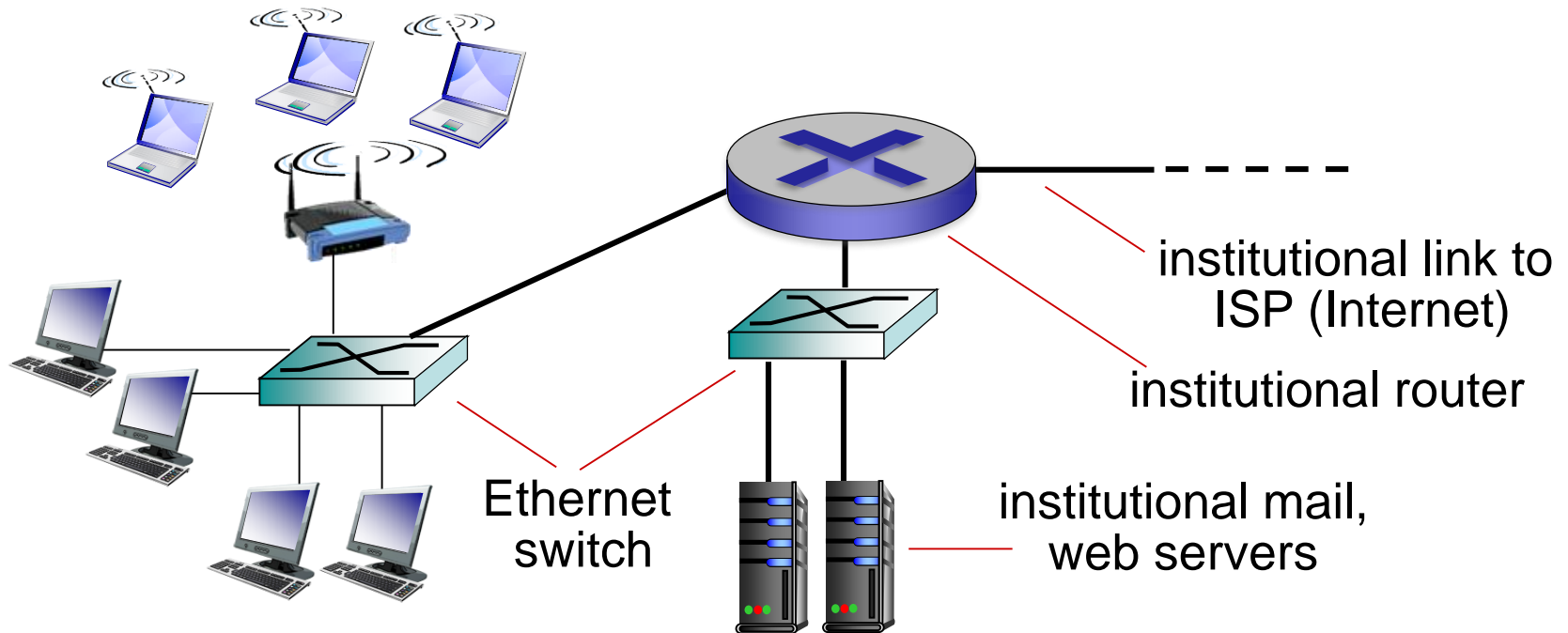

- typically used in companies, universities, etc.
- 10 Mbps, 100Mbps, 1Gbps, 10Gbps transmission rates
- today, end systems typically connect into Ethernet switch

Wireless access networks

- shared *wireless* access network connects end system to router
 - via base station aka “access point”

wireless LANs:

- within building (100 ft.)
- 802.11b/g/n (WiFi): 11, 54, 450 Mbps transmission rate

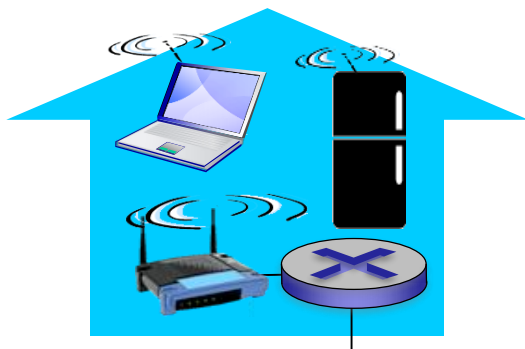

to Internet

wide-area wireless access

- provided by telco (cellular) operator
10' s km
- between 1 and 10 Mbps
- 3G, 4G: LTE



to Internet

Host: sends *packets* of data

host sending function:

- takes application message
- breaks into smaller chunks, known as *packets*, of length L bits
- transmits packet into access network at *transmission rate R*
 - link transmission rate, aka link *capacity*, aka *link bandwidth*

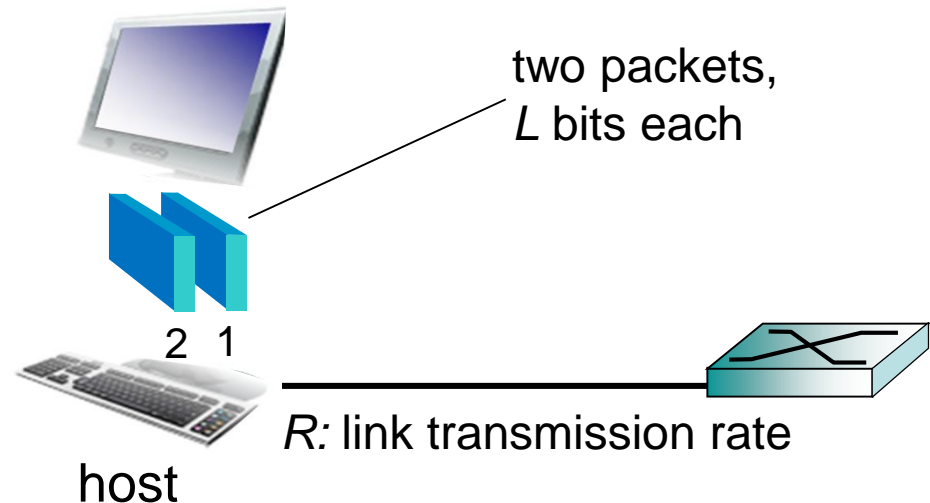

$$\text{packet transmission delay} = \text{time needed to transmit } L\text{-bit packet into link} = \frac{L \text{ (bits)}}{R \text{ (bits/sec)}}$$

Physical media

- **bit:** propagates between transmitter/receiver pairs
- **physical link:** what lies between transmitter & receiver
- **guided media:**
 - signals propagate in solid media: copper, fiber, coax
- **unguided media:**
 - signals propagate freely, e.g., radio

twisted pair (TP)

- two insulated copper wires
 - Category 5: 100 Mbps, 1 Gbps Ethernet
 - Category 6: 10Gbps



Physical media: coax, fiber

coaxial cable:

- two concentric copper conductors
- bidirectional
- broadband:
 - multiple channels on cable
 - HFC

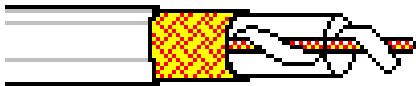

fiber optic cable:

- glass fiber carrying light pulses, each pulse a bit
- high-speed operation:
 - high-speed point-to-point transmission (e.g., 10' s-100' s Gbps transmission rate)
- low error rate:
 - repeaters spaced far apart
 - immune to electromagnetic noise



Physical media: radio

- signal carried in electromagnetic spectrum
- no physical “wire”
- bidirectional
- propagation environment effects:
 - reflection
 - obstruction by objects
 - interference

radio link types:

- **terrestrial microwave**
 - e.g. up to 45 Mbps channels
- **LAN (e.g., WiFi)**
 - 54 Mbps
- **wide-area (e.g., cellular)**
 - 4G cellular: ~ 10 Mbps
- **satellite**
 - Kbps to 45Mbps channel (or multiple smaller channels)
 - 270 msec end-end delay
 - geosynchronous versus low altitude

Chapter 1: roadmap

1.1 what is the Internet?

1.2 network edge

- end systems, access networks, links

1.3 network core

- packet switching, circuit switching, network structure

1.4 delay, loss, throughput in networks

1.5 protocol layers, service models

1.6 networks under attack: security

1.7 history

The network core

- mesh of interconnected routers
- packet-switching: hosts break application-layer messages into *packets*
 - forward packets from one router to the next, across links on path from source to destination
 - each packet transmitted at full link capacity

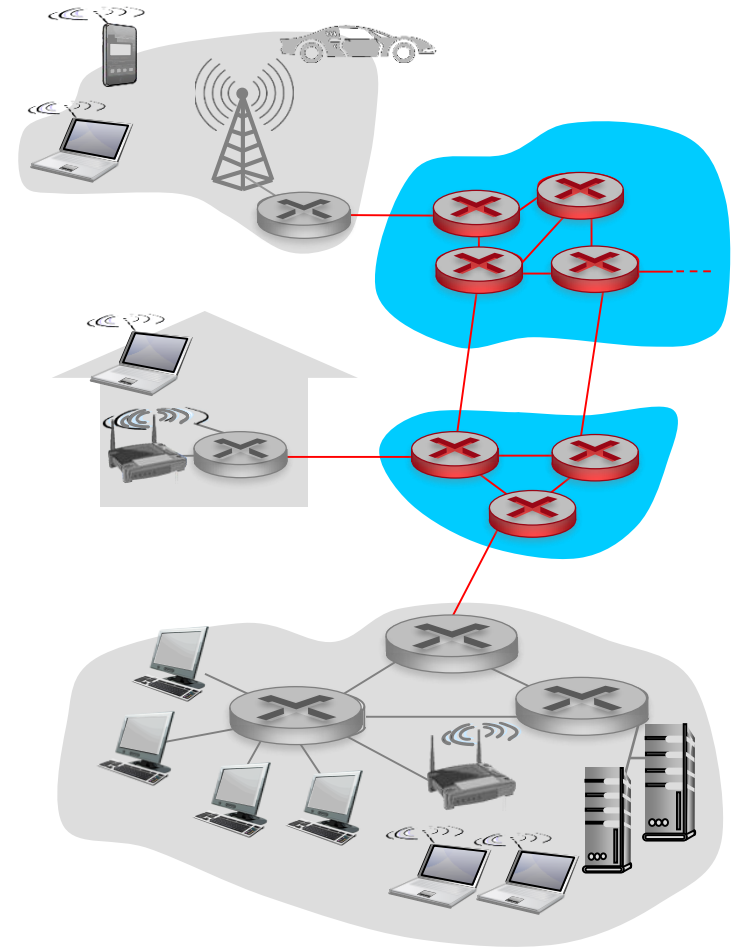

Packet-switching: store-and-forward

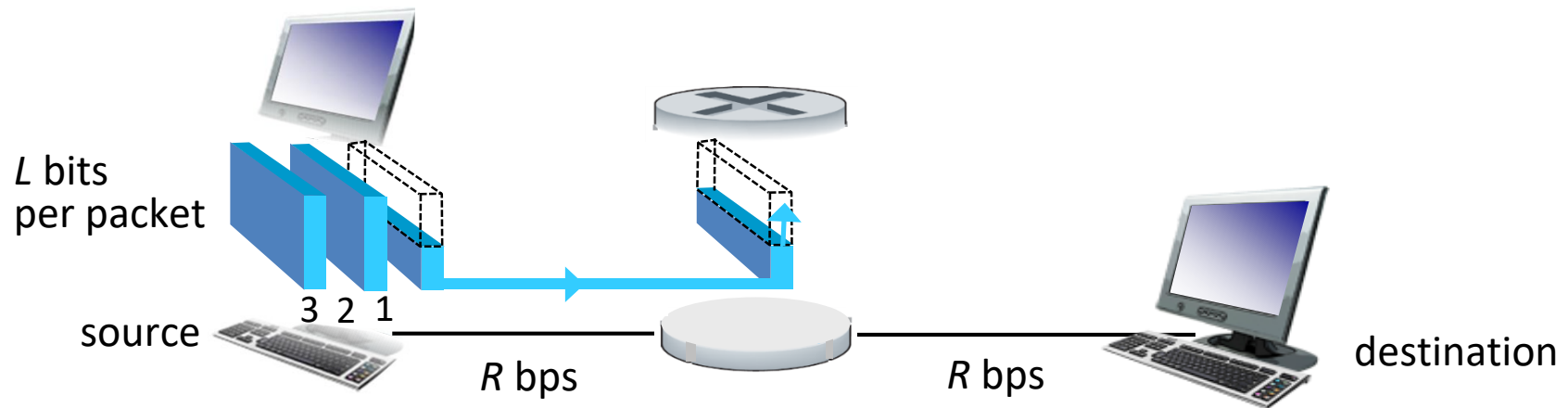

- takes L/R seconds to transmit (push out) L -bit packet into link at R bps
- *store and forward*: entire packet must arrive at router before it can be transmitted on next link
- end-end delay = $2L/R$ (assuming zero propagation delay)

one-hop numerical example:

- $L = 7.5$ Mbits
- $R = 1.5$ Mbps
- one-hop transmission delay = 5 sec

} more on delay shortly ...

Packet Switching: queueing delay, loss

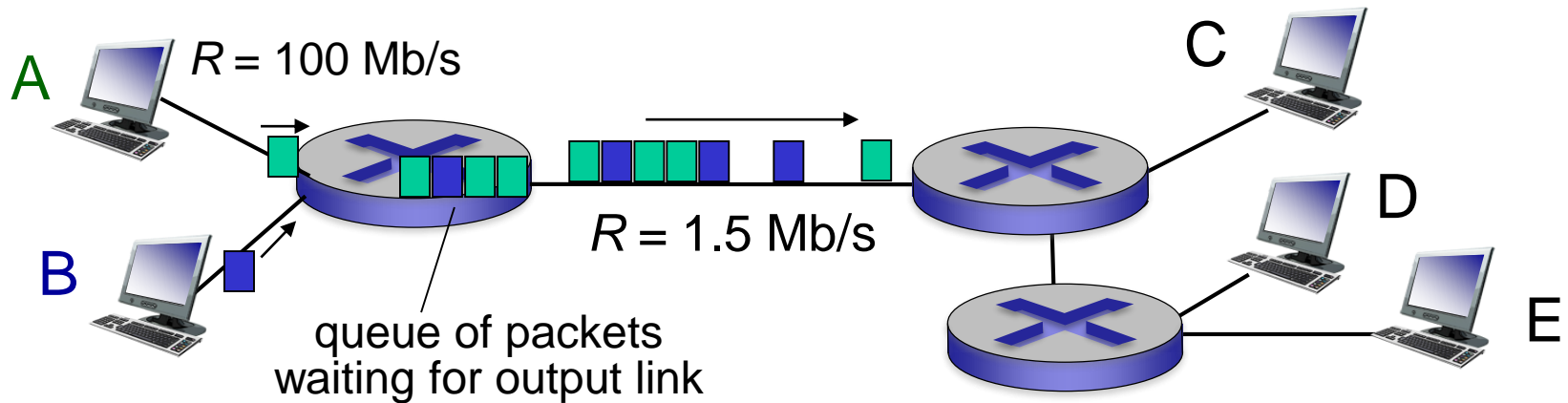

queuing and loss:

- if arrival rate (in bits) to link exceeds transmission rate of link for a period of time:
 - packets will queue, wait to be transmitted on link
 - packets can be dropped (lost) if memory (buffer) fills up

Two key network-core functions

routing: determines source-destination route taken by packets

- *routing algorithms*

forwarding: move packets from router's input to appropriate router output

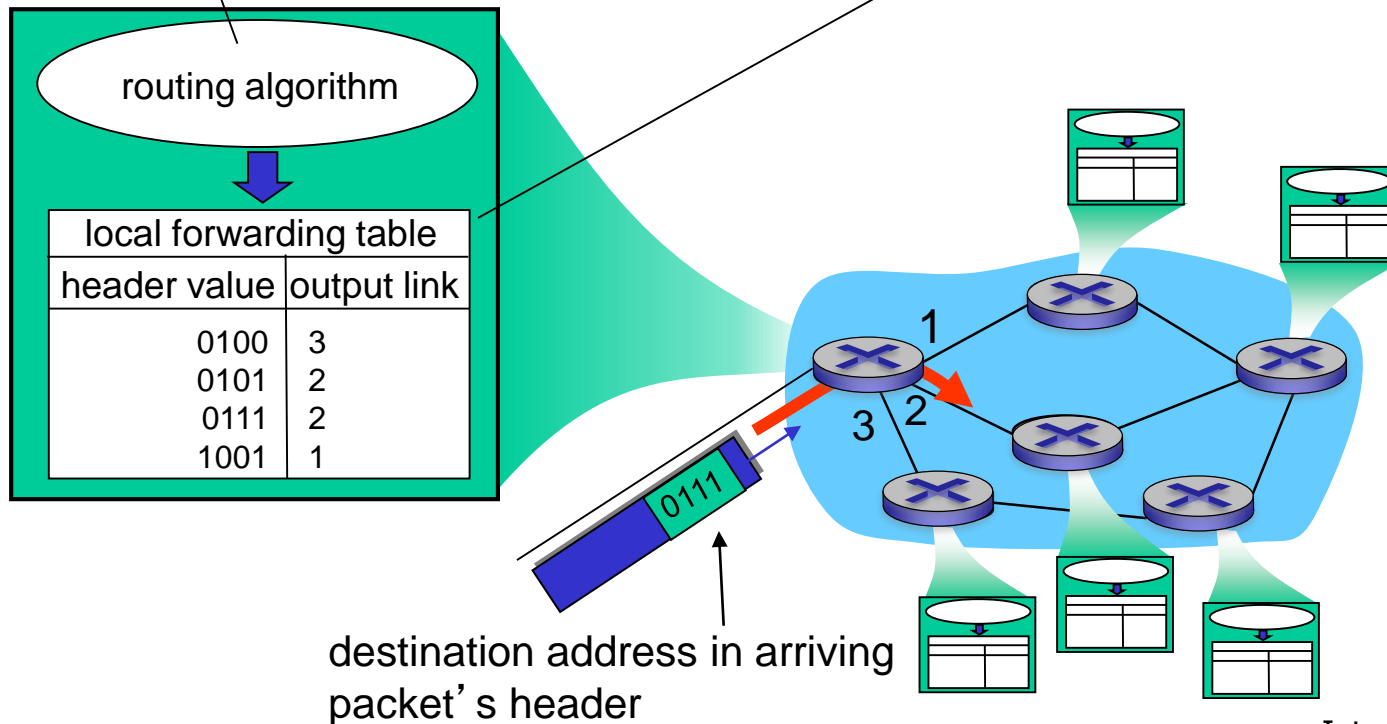

Alternative core: circuit switching

end-end resources allocated to, reserved for “call” between source & dest:

- in diagram, each link has four circuits.
 - call gets 2nd circuit in top link and 1st circuit in right link.
- dedicated resources: no sharing
 - circuit-like (guaranteed) performance
- circuit segment idle if not used by call (*no sharing*)
- commonly used in traditional telephone networks

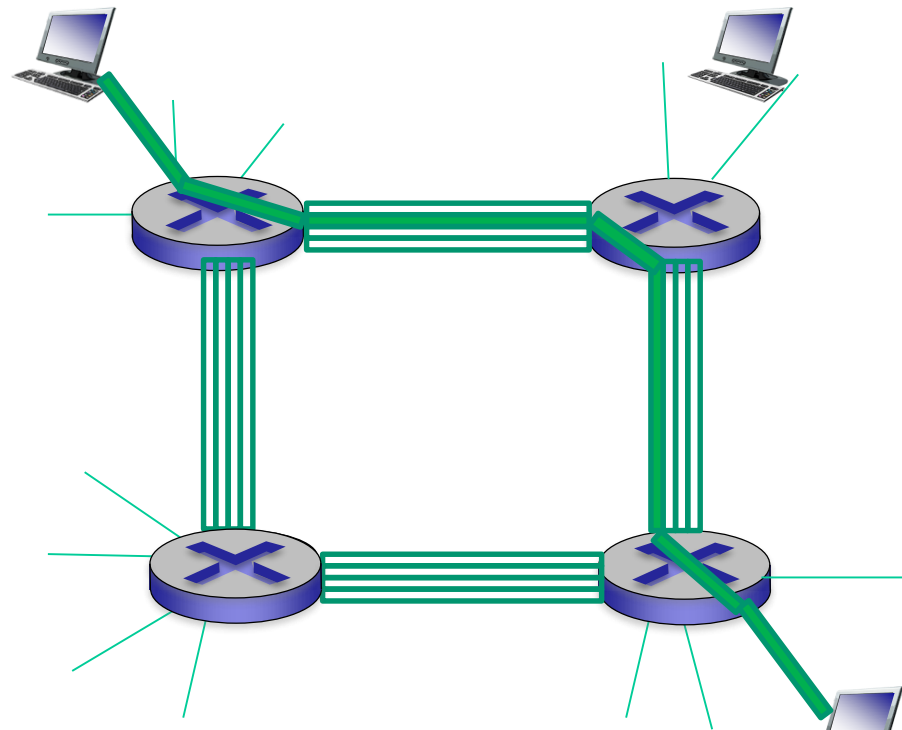

Circuit switching: FDM versus TDM

FDM

Example:

4 users

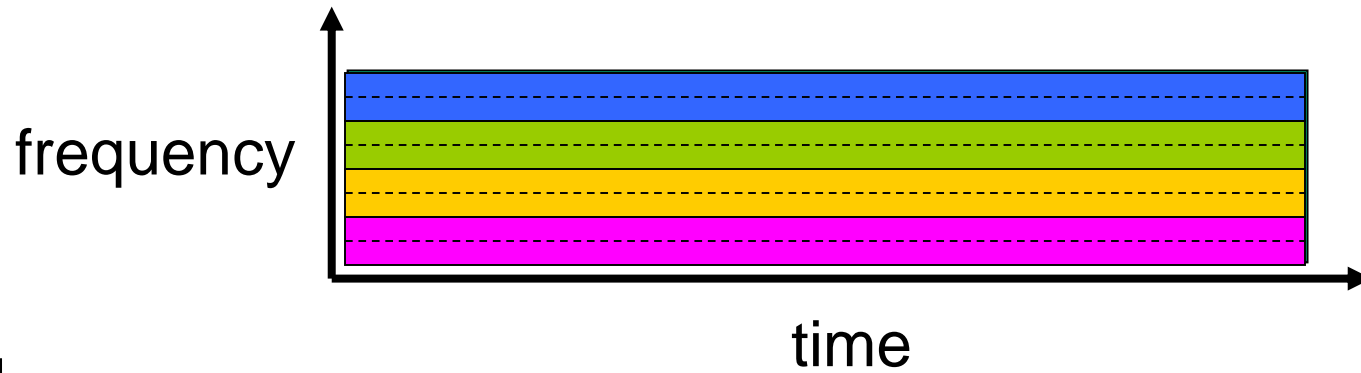

TDM

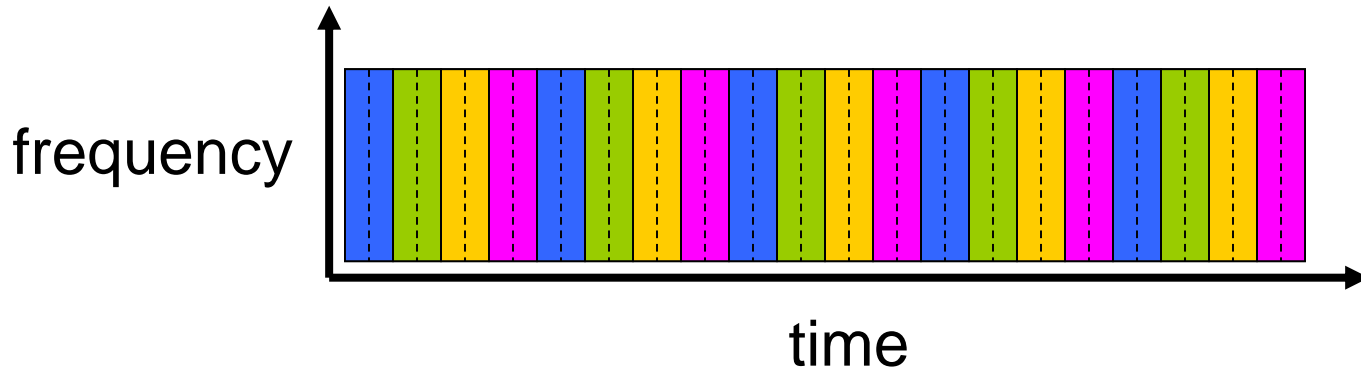

Packet switching versus circuit switching

packet switching allows more users to use network!

example:

- 1 Mb/s link
- each user:
 - 100 kb/s when “active”
 - active 10% of time
- *circuit-switching*:
 - 10 users
- *packet switching*:
 - with 35 users, probability > 10 active at same time is less than .0004 *

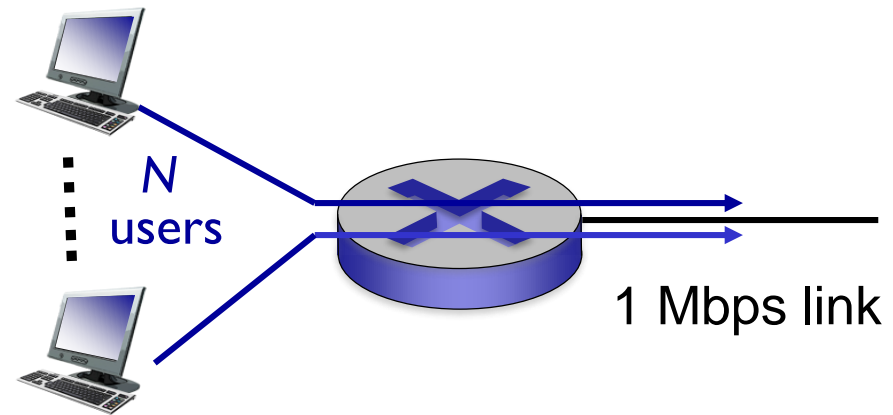

Q: how did we get value 0.0004?

Q: what happens if > 35 users ?

* Check out the online interactive exercises for more examples: http://gaia.cs.umass.edu/kurose_ross/interactive/

Packet switching versus circuit switching

is packet switching a “slam dunk winner?”

- great for bursty data
 - resource sharing
 - simpler, no call setup
- **excessive congestion possible:** packet delay and loss
 - protocols needed for reliable data transfer, congestion control
- **Q: How to provide circuit-like behavior?**
 - bandwidth guarantees needed for audio/video apps
 - still an unsolved problem (chapter 7)

Q: human analogies of reserved resources (circuit switching) versus on-demand allocation (packet-switching)?

Internet structure: network of networks

- End systems connect to Internet via **access ISPs** (Internet Service Providers)
 - residential, company and university ISPs
- Access ISPs in turn must be interconnected.
 - so that any two hosts can send packets to each other
- Resulting network of networks is very complex
 - evolution was driven by **economics** and **national policies**
- Let's take a stepwise approach to describe current Internet structure

Internet structure: network of networks

Question: given *millions* of access ISPs, how to connect them together?

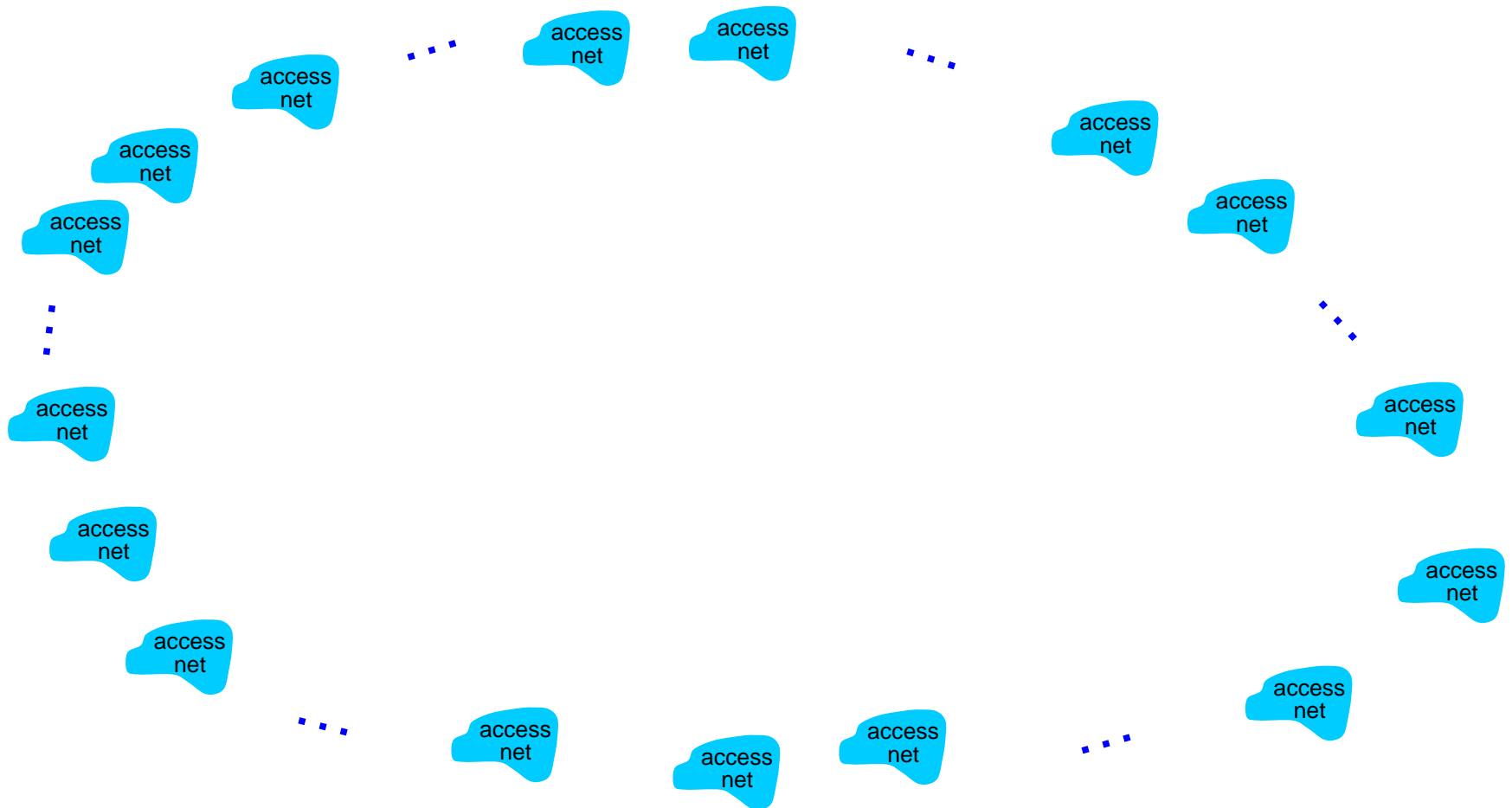

Internet structure: network of networks

Option: connect each access ISP to every other access ISP?

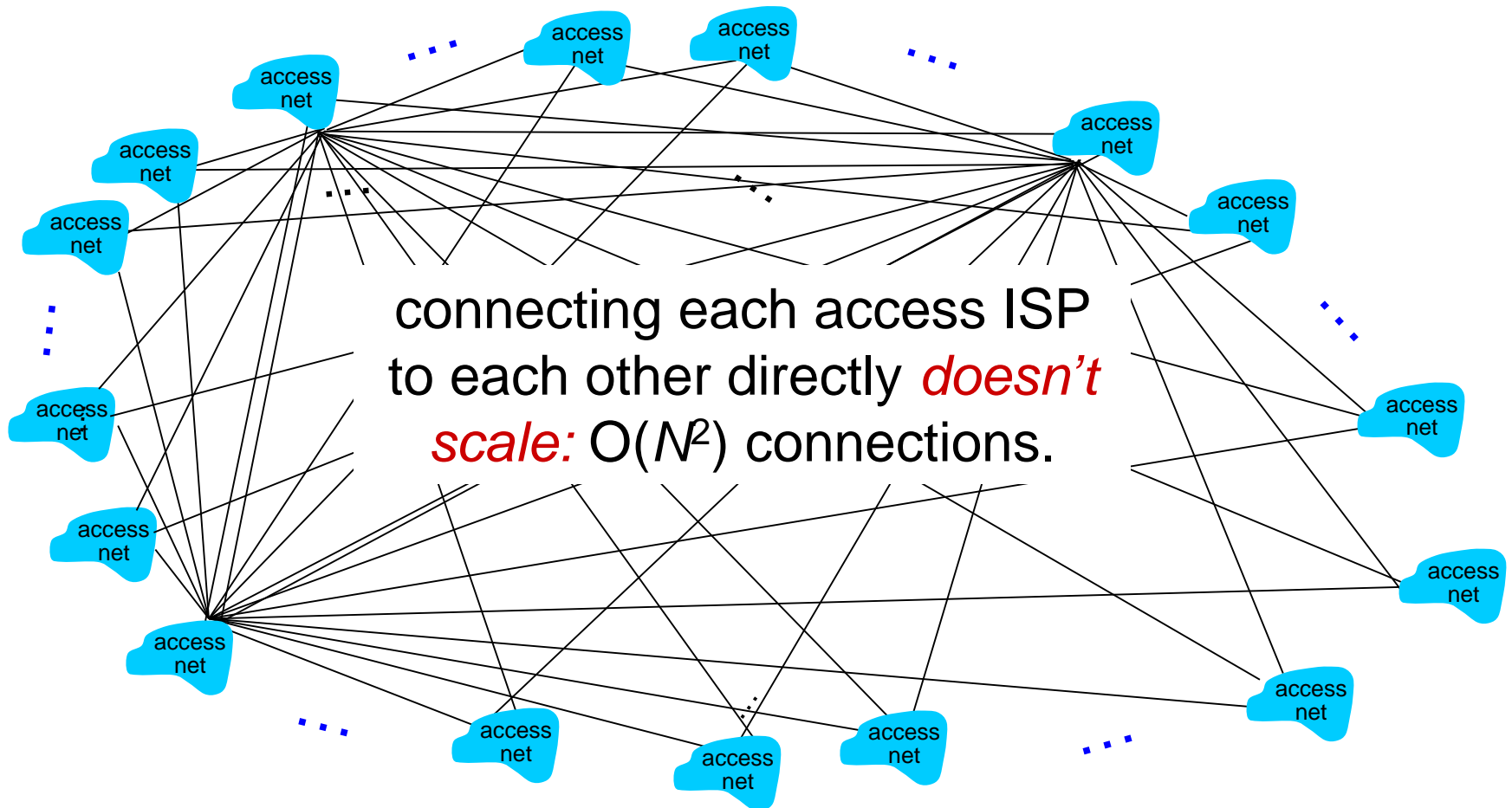

Internet structure: network of networks

Option: connect each access ISP to one global transit ISP?

Customer and *provider* ISPs have economic agreement.

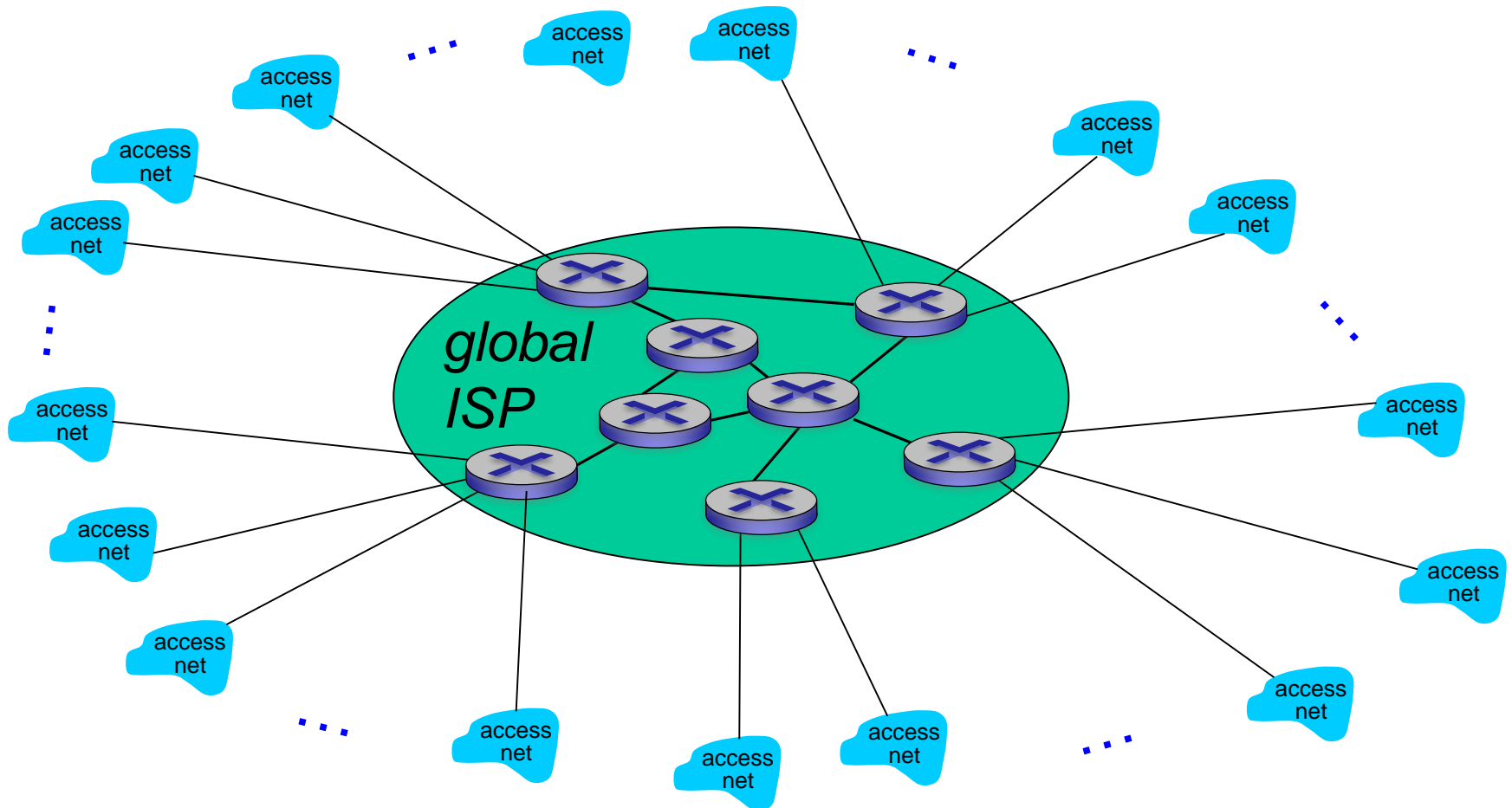

Internet structure: network of networks

But if one global ISP is viable business, there will be competitors

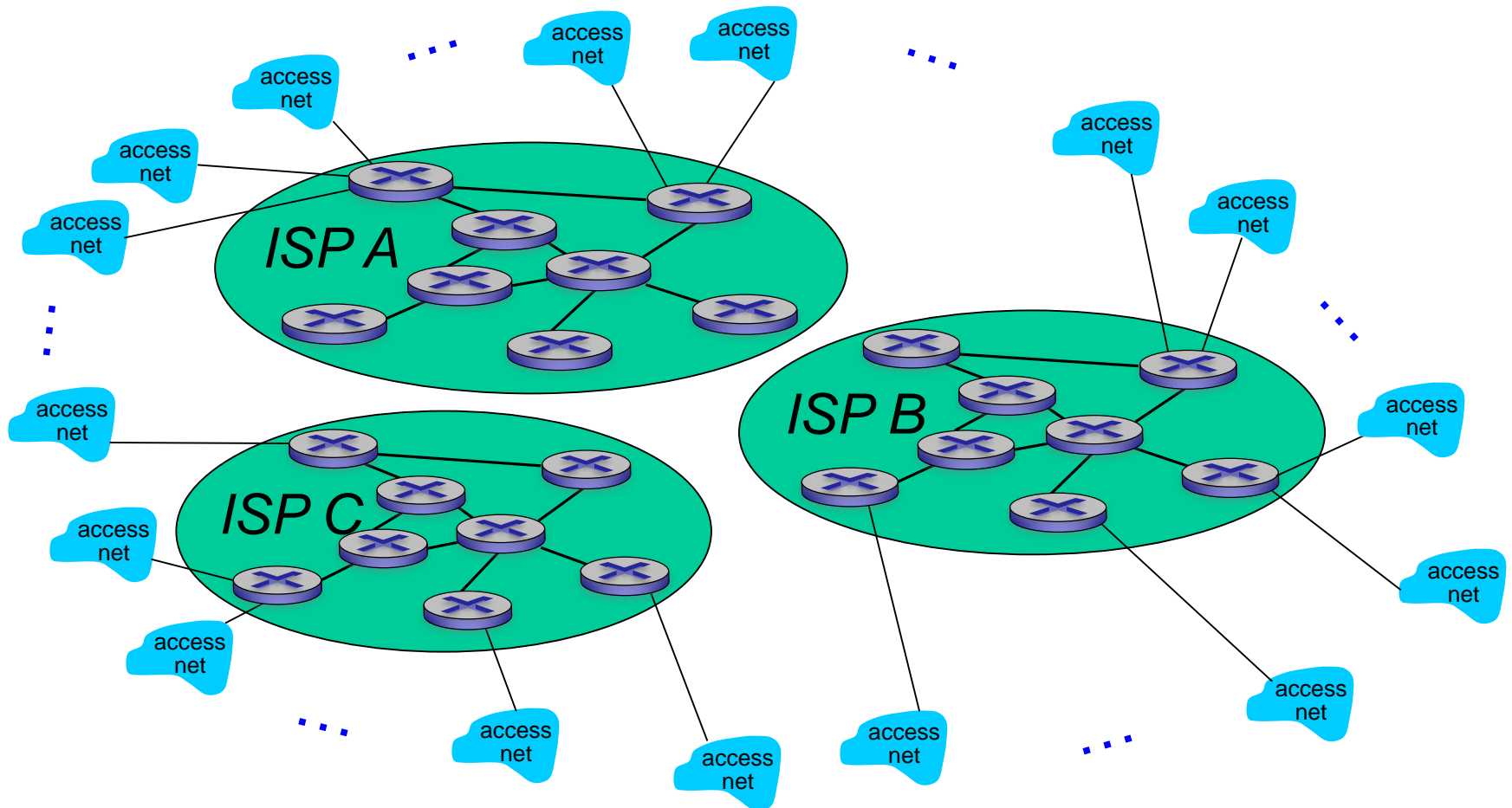

Internet structure: network of networks

But if one global ISP is viable business, there will be competitors which must be interconnected

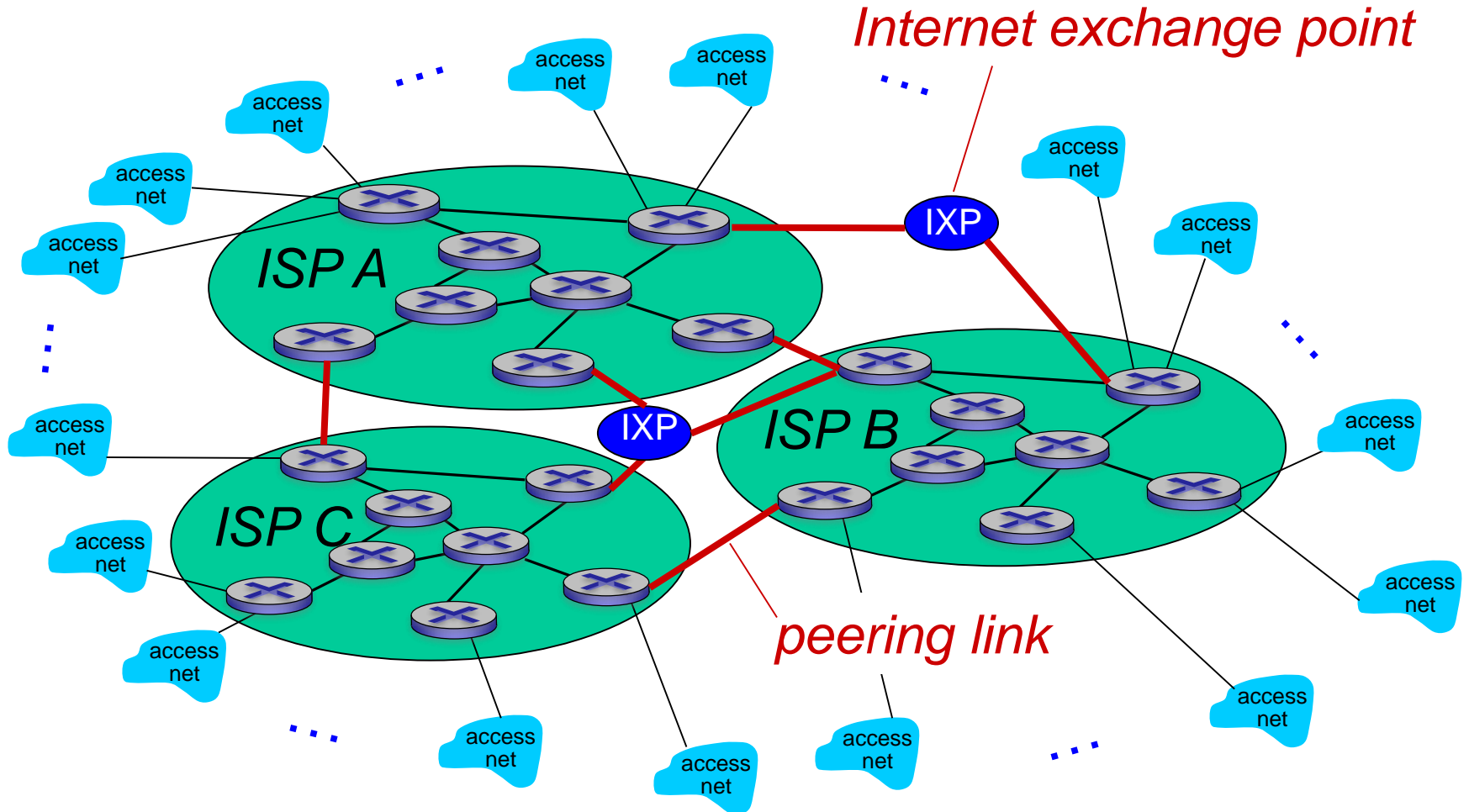

Internet structure: network of networks

... and regional networks may arise to connect access nets to ISPs

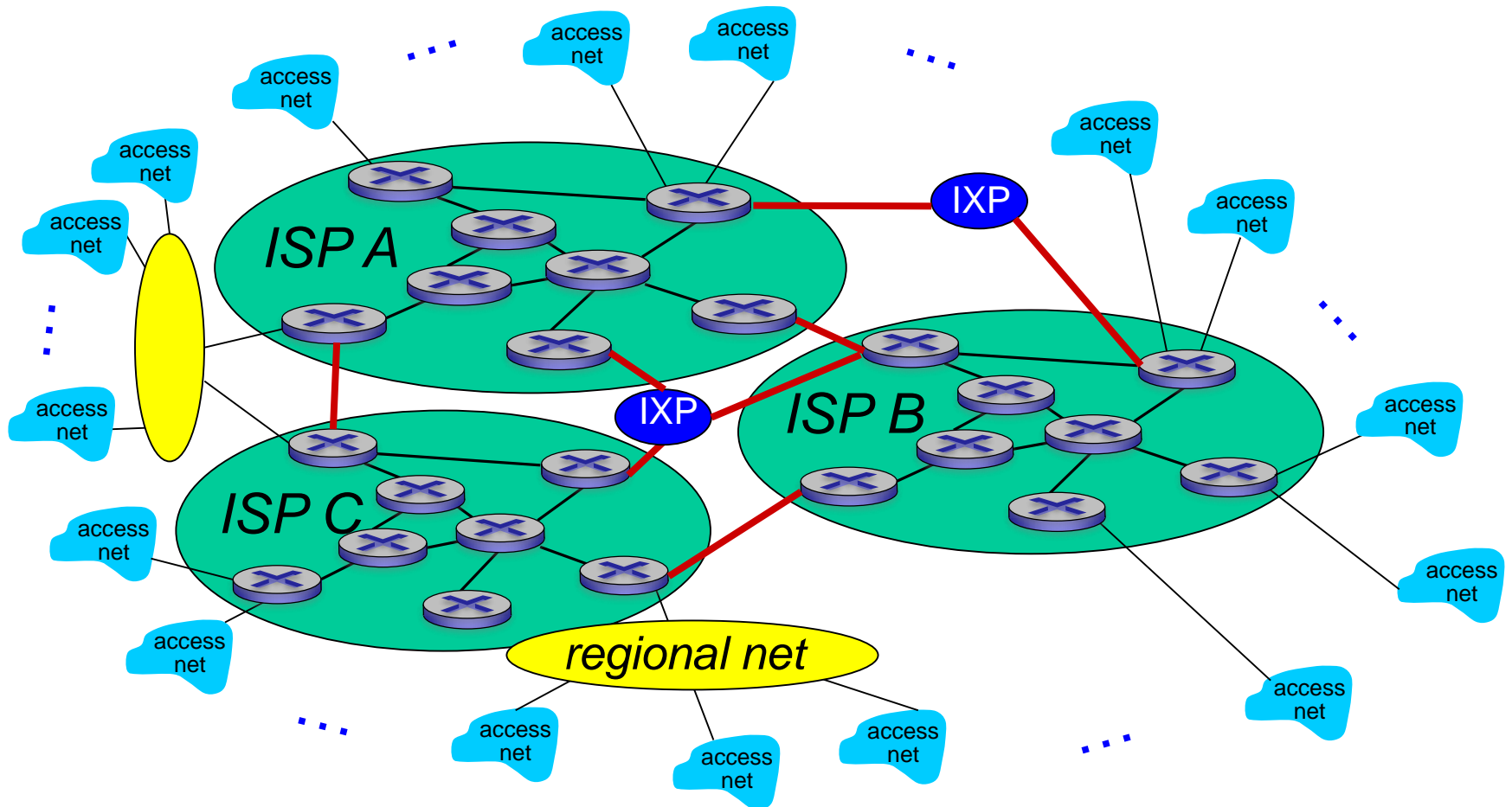

Internet structure: network of networks

... and content provider networks (e.g., Google, Microsoft, Akamai) may run their own network, to bring services, content close to end users

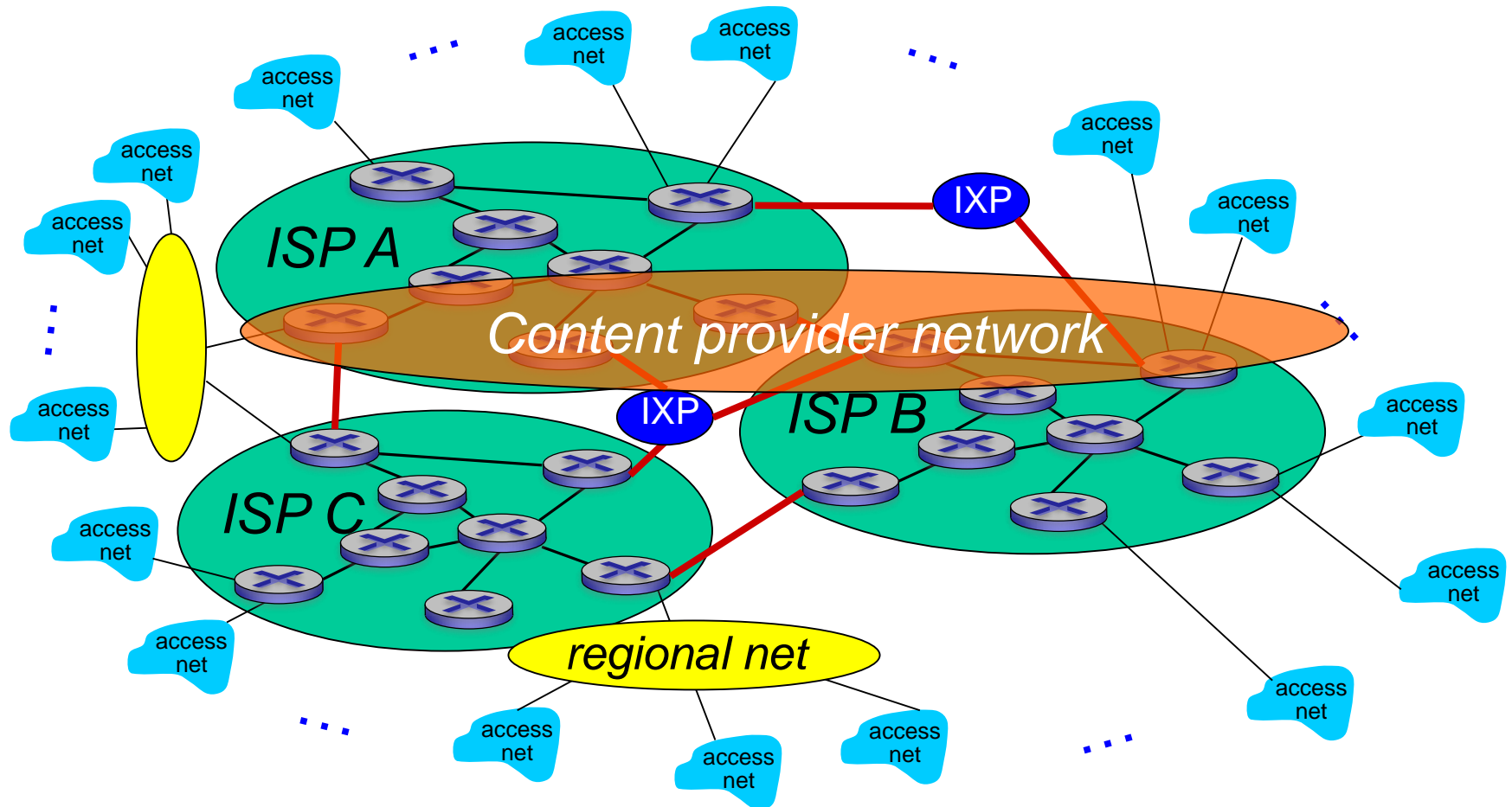

Internet structure: network of networks

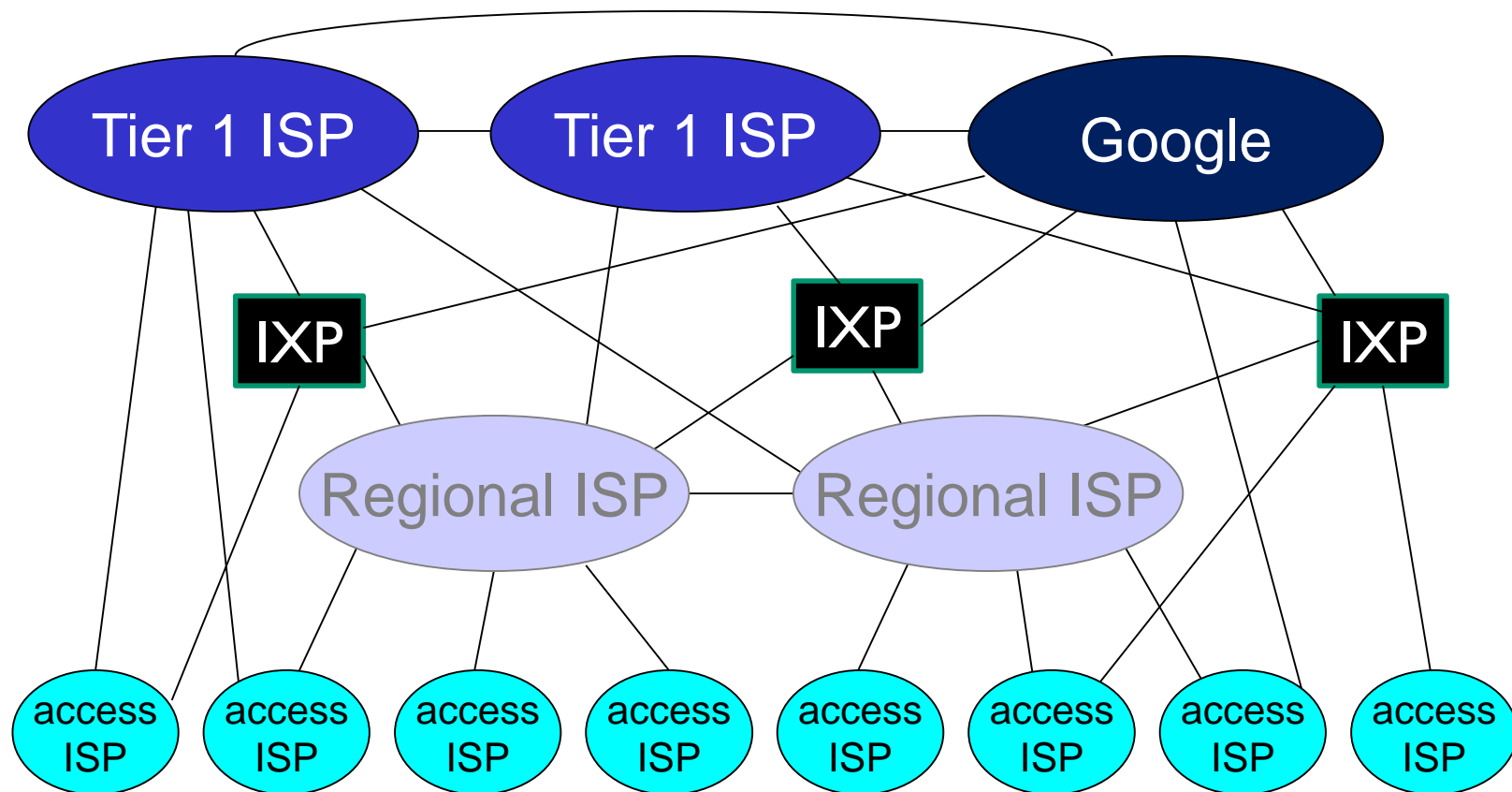

- at center: small # of well-connected large networks
 - “**tier-1**” **commercial ISPs** (e.g., Level 3, Sprint, AT&T, NTT), national & international coverage
 - **content provider network** (e.g., Google): private network that connects its data centers to Internet, often bypassing tier-1, regional ISPs

Tier-1 ISP: e.g., Sprint

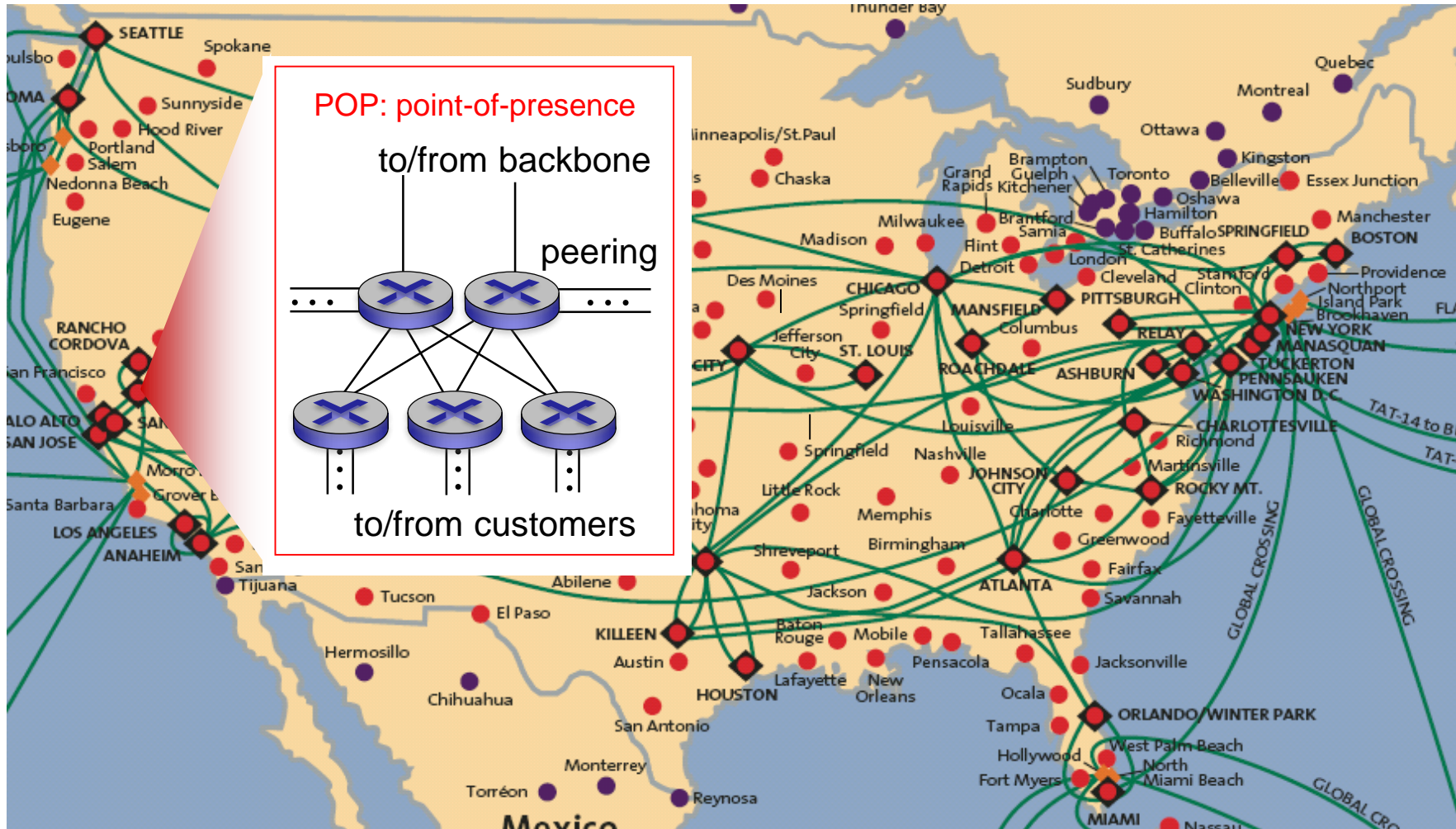

Chapter 1: roadmap

1.1 what *is* the Internet?

1.2 network edge

- end systems, access networks, links

1.3 network core

- packet switching, circuit switching, network structure

1.4 delay, loss, throughput in networks

1.5 protocol layers, service models

1.6 networks under attack: security

1.7 history

How do loss and delay occur?

packets *queue* in router buffers

- packet arrival rate to link (temporarily) exceeds output link capacity
- packets queue, wait for turn

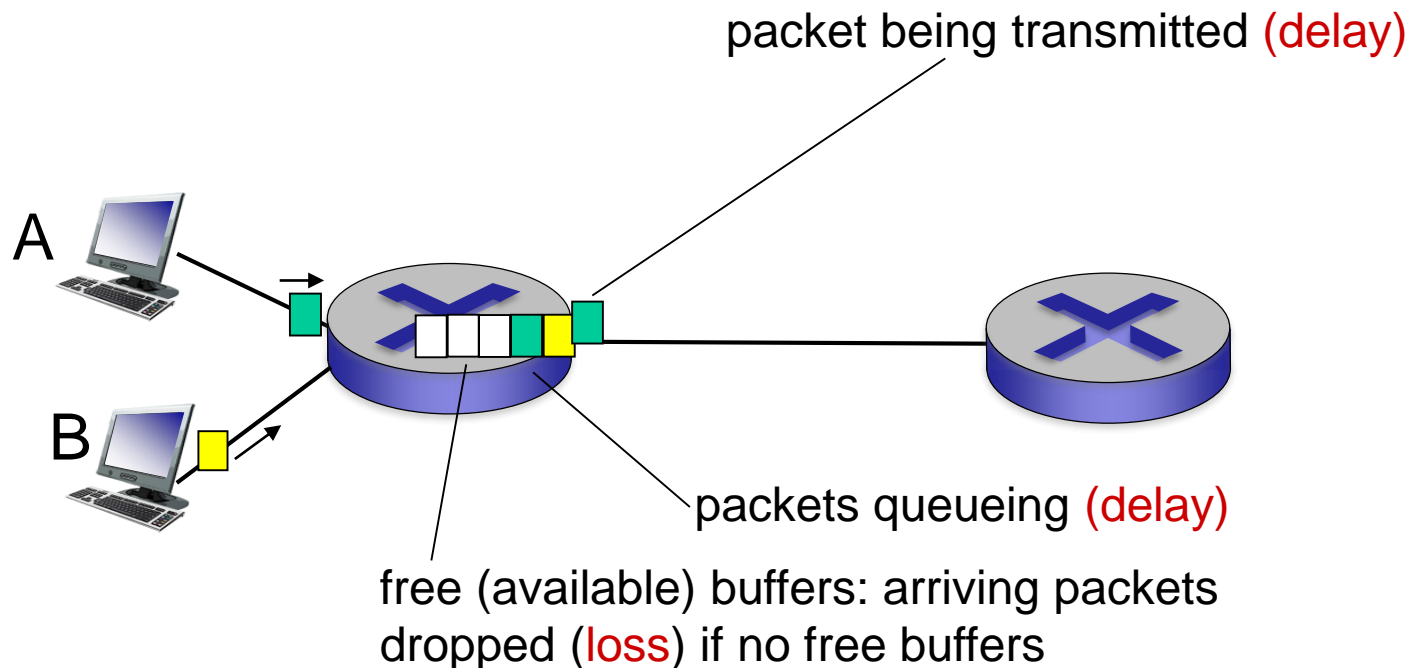

Four sources of packet delay

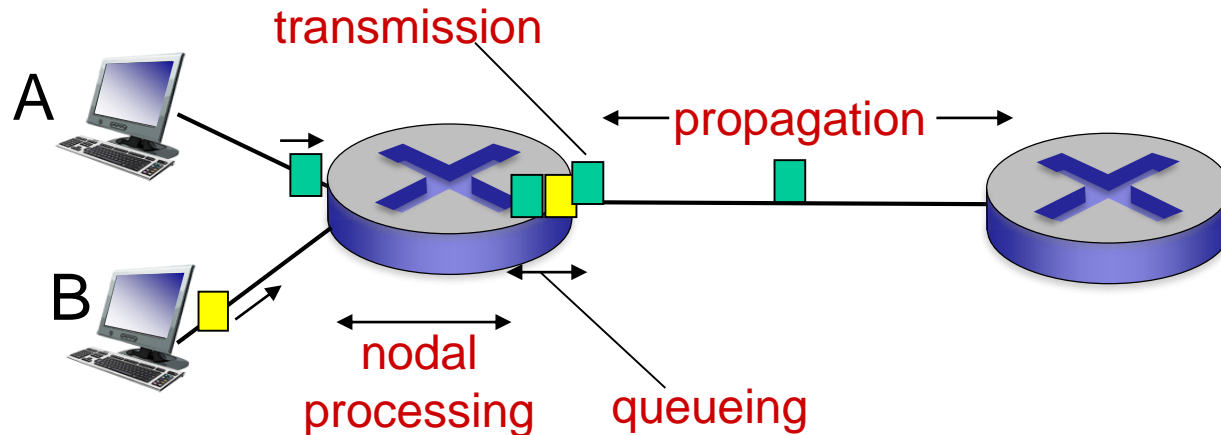

$$d_{\text{nodal}} = d_{\text{proc}} + d_{\text{queue}} + d_{\text{trans}} + d_{\text{prop}}$$

d_{proc} : nodal processing

- check bit errors
- determine output link
- typically < msec

d_{queue} : queueing delay

- time waiting at output link for transmission
- depends on congestion level of router

Four sources of packet delay

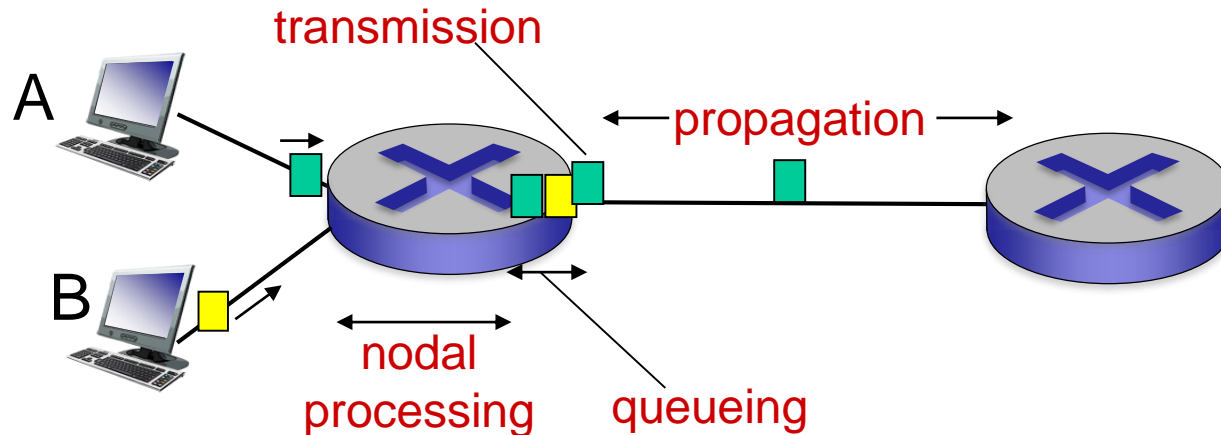

$$d_{\text{nodal}} = d_{\text{proc}} + d_{\text{queue}} + d_{\text{trans}} + d_{\text{prop}}$$

d_{trans} : transmission delay:

- L : packet length (bits)
- R : link bandwidth (bps)
- $d_{\text{trans}} = L/R$

d_{prop} : propagation delay:

- d : length of physical link
- s : propagation speed ($\sim 2 \times 10^8$ m/sec)
- $d_{\text{prop}} = d/s$

← d_{trans} and d_{prop} →
very different

* Check out the online interactive exercises for more examples: http://gaia.cs.umass.edu/kurose_ross/interactive/

* Check out the Java applet for an interactive animation on trans vs. prop delay

Caravan analogy

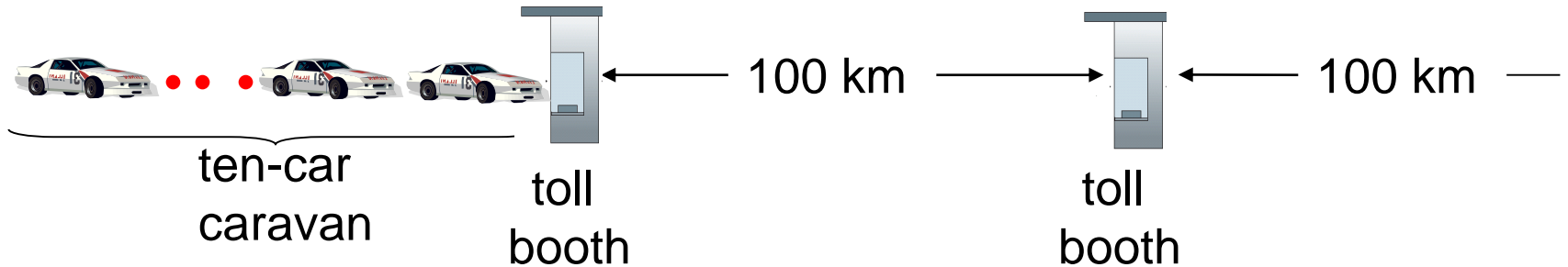

- cars “propagate” at 100 km/hr
- toll booth takes 12 sec to service car (bit transmission time)
- car ~ bit; caravan ~ packet
- **Q: How long until caravan is lined up before 2nd toll booth?**
- time to “push” entire caravan through toll booth onto highway = $12 * 10 = 120$ sec
- time for last car to propagate from 1st to 2nd toll booth: $100\text{km} / (100\text{km/hr}) = 1$ hr
- **A: 62 minutes**

Caravan analogy (more)

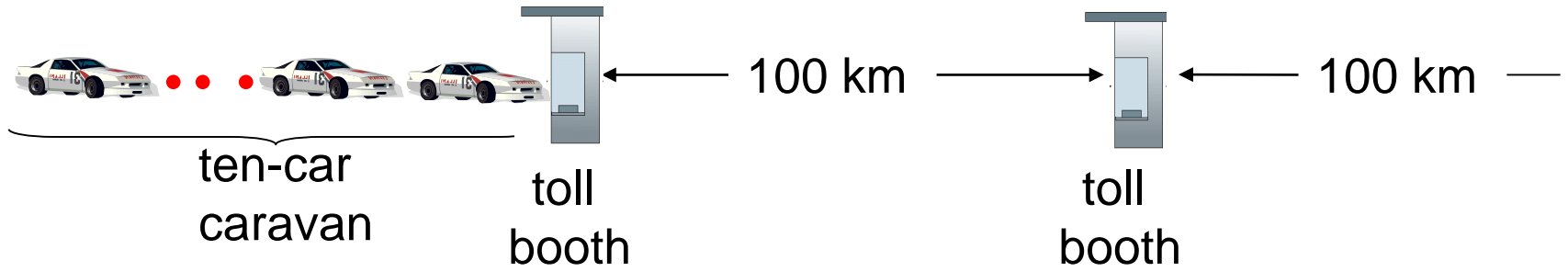

- suppose cars now “propagate” at 1000 km/hr
- and suppose toll booth now takes one min to service a car
- **Q: Will cars arrive to 2nd booth before all cars serviced at first booth?**
 - **A: Yes!** after 7 min, first car arrives at second booth; three cars still at first booth

Queueing delay (revisited)

- R : link bandwidth (bps)
- L : packet length (bits)
- a : average packet arrival rate

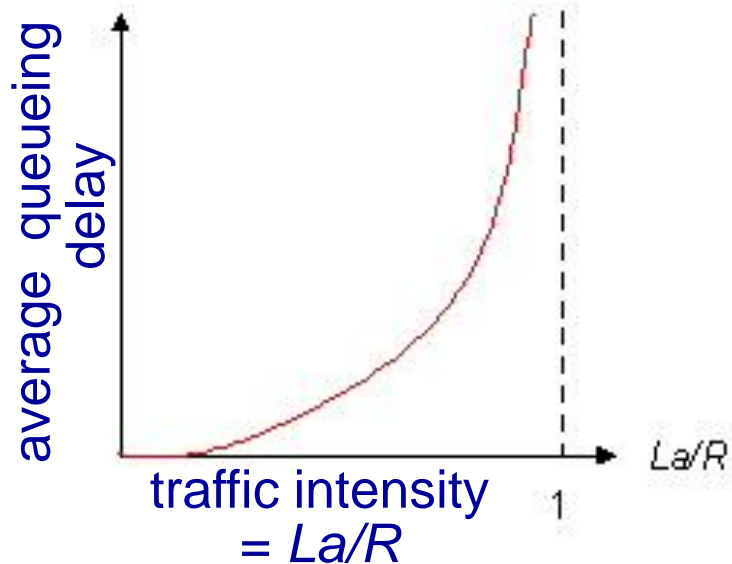

- $La/R \sim 0$: avg. queueing delay small
- $La/R \rightarrow 1$: avg. queueing delay large
- $La/R > 1$: more “work” arriving than can be serviced, average delay infinite!



$La/R \sim 0$



$La/R \rightarrow 1$

* Check online interactive animation on queuing and loss

“Real” Internet delays and routes

- what do “real” Internet delay & loss look like?
- **traceroute** program: provides delay measurement from source to router along end-end Internet path towards destination. For all i :
 - sends three packets that will reach router i on path towards destination
 - router i will return packets to sender
 - sender times interval between transmission and reply.

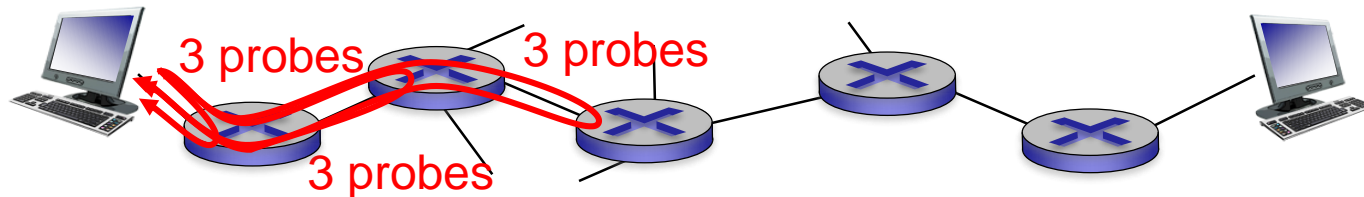

“Real” Internet delays, routes

traceroute: gaia.cs.umass.edu to www.eurecom.fr

3 delay measurements from
gaia.cs.umass.edu to cs-gw.cs.umass.edu



1 cs-gw (128.119.240.254) 1 ms 1 ms 2 ms
2 border1-rt-fa5-1-0.gw.umass.edu (128.119.3.145) 1 ms 1 ms 2 ms
3 cht-vbns.gw.umass.edu (128.119.3.130) 6 ms 5 ms 5 ms
4 jn1-at1-0-0-19.wor.vbns.net (204.147.132.129) 16 ms 11 ms 13 ms
5 jn1-so7-0-0-0.wae.vbns.net (204.147.136.136) 21 ms 18 ms 18 ms
6 abilene-vbns.abilene.ucaid.edu (198.32.11.9) 22 ms 18 ms 22 ms
7 nycm-wash.abilene.ucaid.edu (198.32.8.46) 22 ms 22 ms 22 ms
8 62.40.103.253 (62.40.103.253) 104 ms 109 ms 106 ms
9 de2-1.de1.de.geant.net (62.40.96.129) 109 ms 102 ms 104 ms
10 de.fr1.fr.geant.net (62.40.96.50) 113 ms 121 ms 114 ms
11 renater-gw.fr1.fr.geant.net (62.40.103.54) 112 ms 114 ms 112 ms
12 nio-n2.cssi.renater.fr (193.51.206.13) 111 ms 114 ms 116 ms
13 nice.cssi.renater.fr (195.220.98.102) 123 ms 125 ms 124 ms
14 r3t2-nice.cssi.renater.fr (195.220.98.110) 126 ms 126 ms 124 ms
15 eurecom-valbonne.r3t2.ft.net (193.48.50.54) 135 ms 128 ms 133 ms
16 194.214.211.25 (194.214.211.25) 126 ms 128 ms 126 ms
17 * * *
18 * * * * means no response (probe lost, router not replying)
19 fantasia.eurecom.fr (193.55.113.142) 132 ms 128 ms 136 ms

trans-oceanic link



* Do some traceroutes from exotic countries at www.traceroute.org

Packet loss

- queue (aka buffer) preceding link in buffer has finite capacity
- packet arriving to full queue dropped (aka lost)
- lost packet may be retransmitted by previous node, by source end system, or not at all

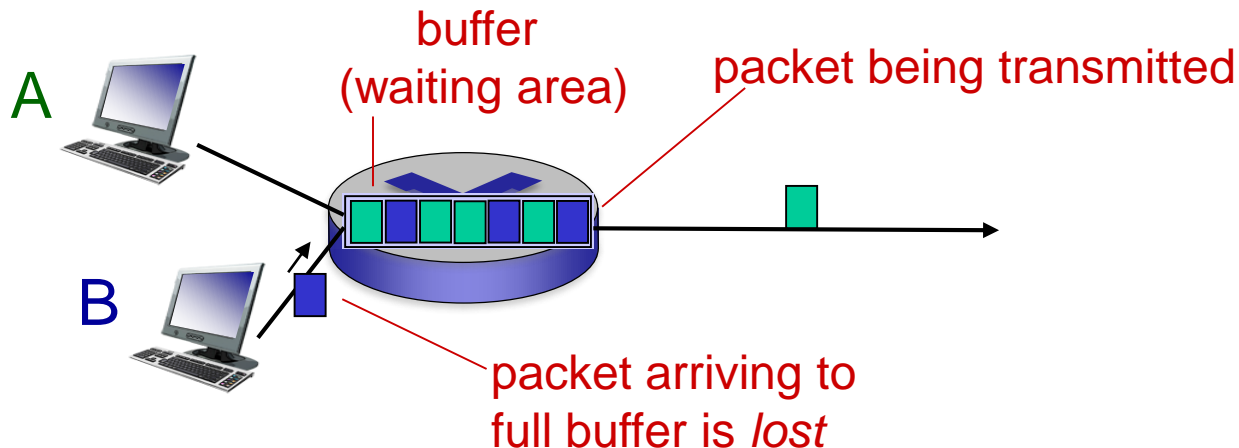

* Check out the Java applet for an interactive animation on queuing and loss

Throughput

- **throughput**: rate (bits/time unit) at which bits transferred between sender/receiver
 - **instantaneous**: rate at given point in time
 - **average**: rate over longer period of time

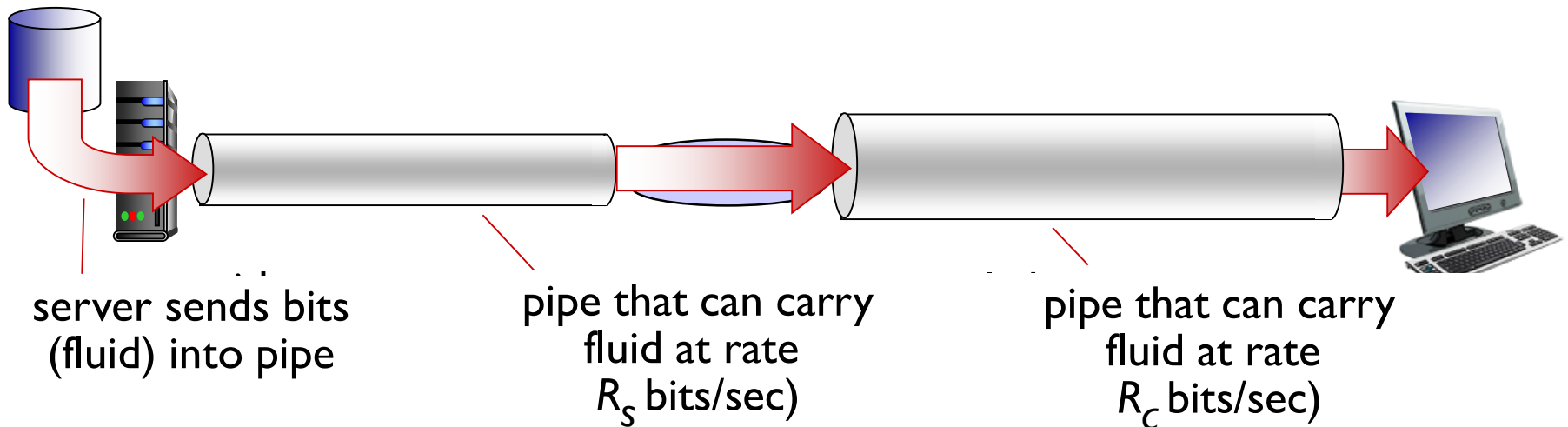

Throughput (more)

- $R_s < R_c$ What is average end-end throughput?

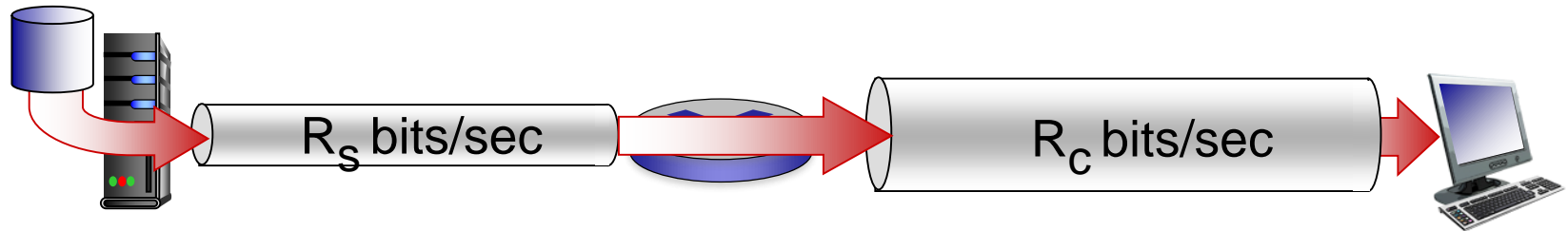

- $R_s > R_c$ What is average end-end throughput?

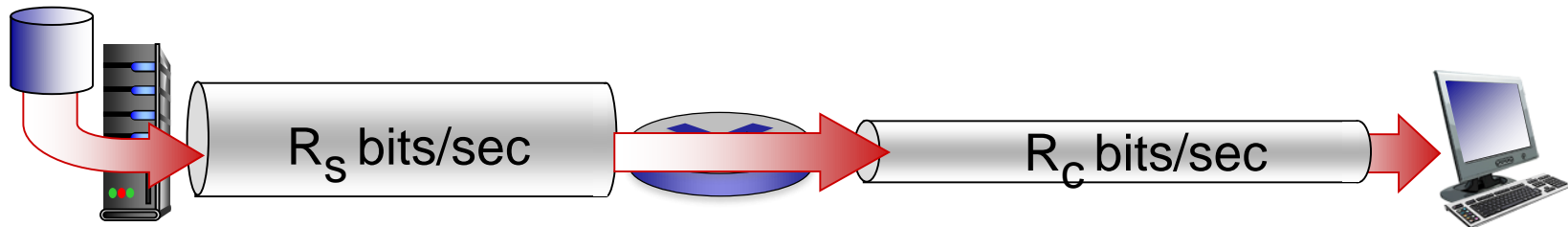

bottleneck link

link on end-end path that constrains end-end throughput

Throughput: Internet scenario

- per-connection end-end throughput:
 $\min(R_c, R_s, R/I)$
- in practice: R_c or R_s is often bottleneck

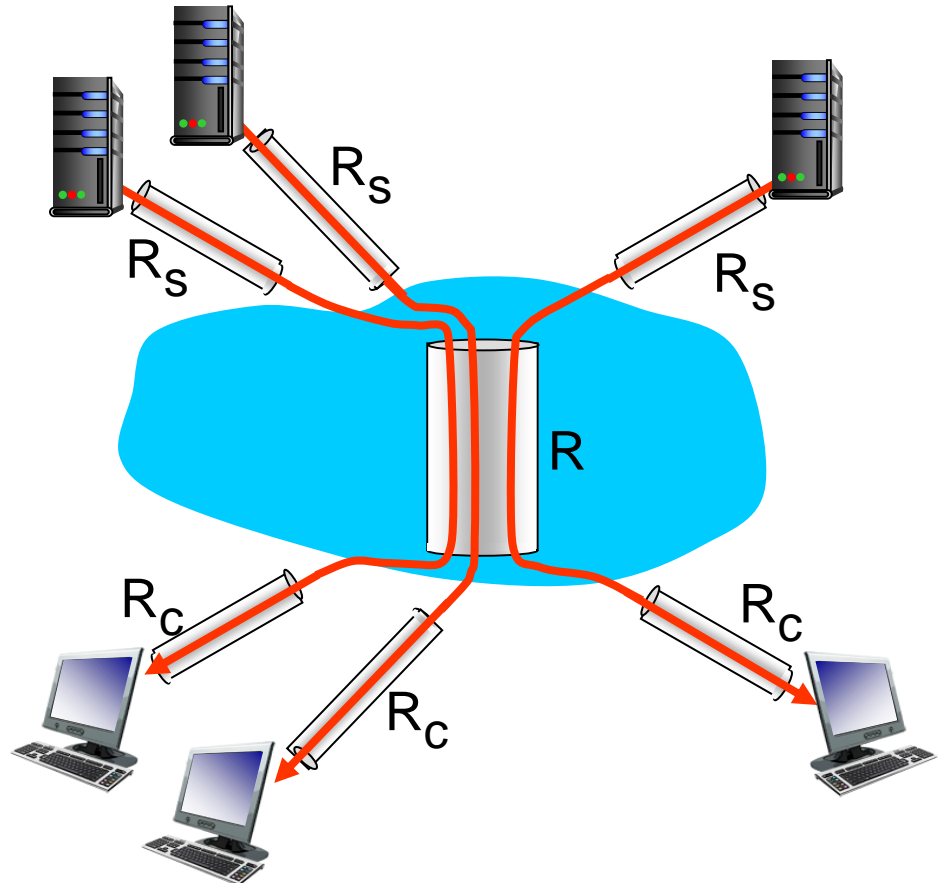

10 connections (fairly) share backbone bottleneck link R bits/sec

* Check out the online interactive exercises for more examples: http://gaia.cs.umass.edu/kurose_ross/interactive/

Chapter 1: roadmap

1.1 what *is* the Internet?

1.2 network edge

- end systems, access networks, links

1.3 network core

- packet switching, circuit switching, network structure

1.4 delay, loss, throughput in networks

1.5 protocol layers, service models

1.6 networks under attack: security

1.7 history

Protocol “layers”

*Networks are complex,
with many “pieces”:*

- hosts
- routers
- links of various media
- applications
- protocols
- hardware, software

Question:

is there any hope of
organizing structure of
network?

.... or at least our
discussion of networks?

Organization of air travel

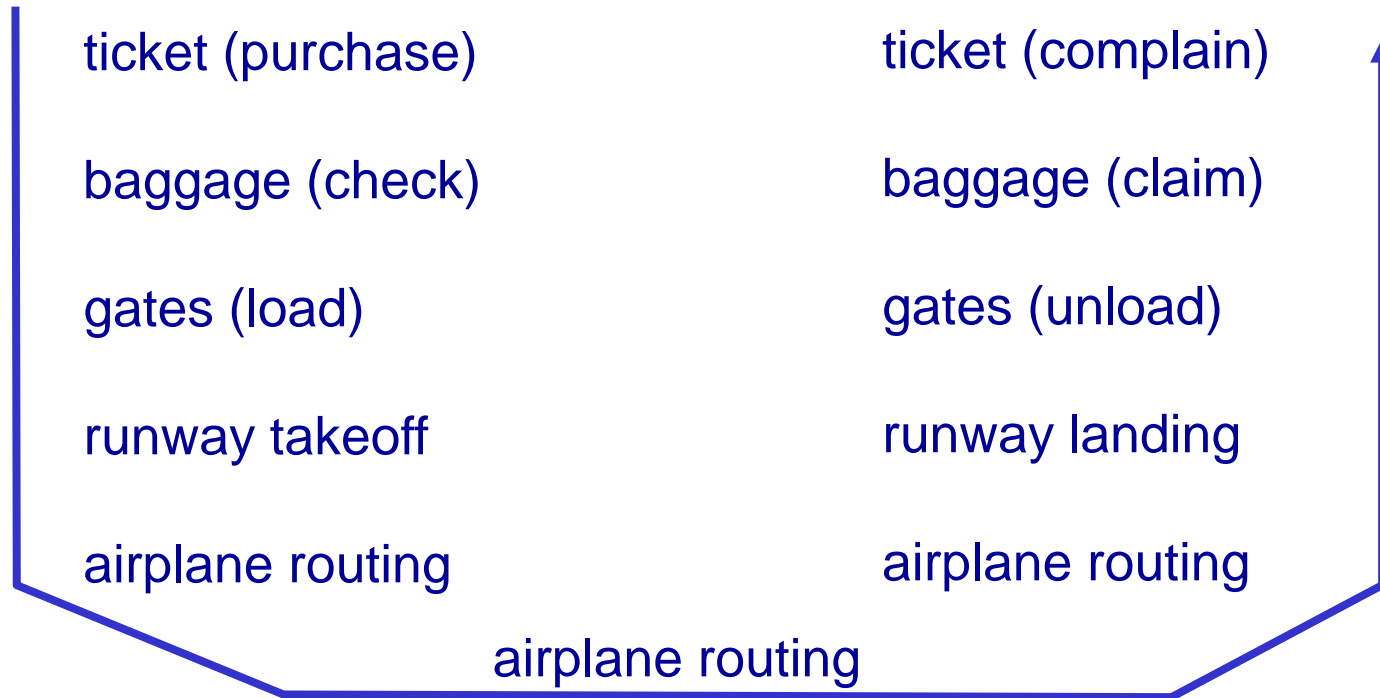

- a series of steps

Layering of airline functionality

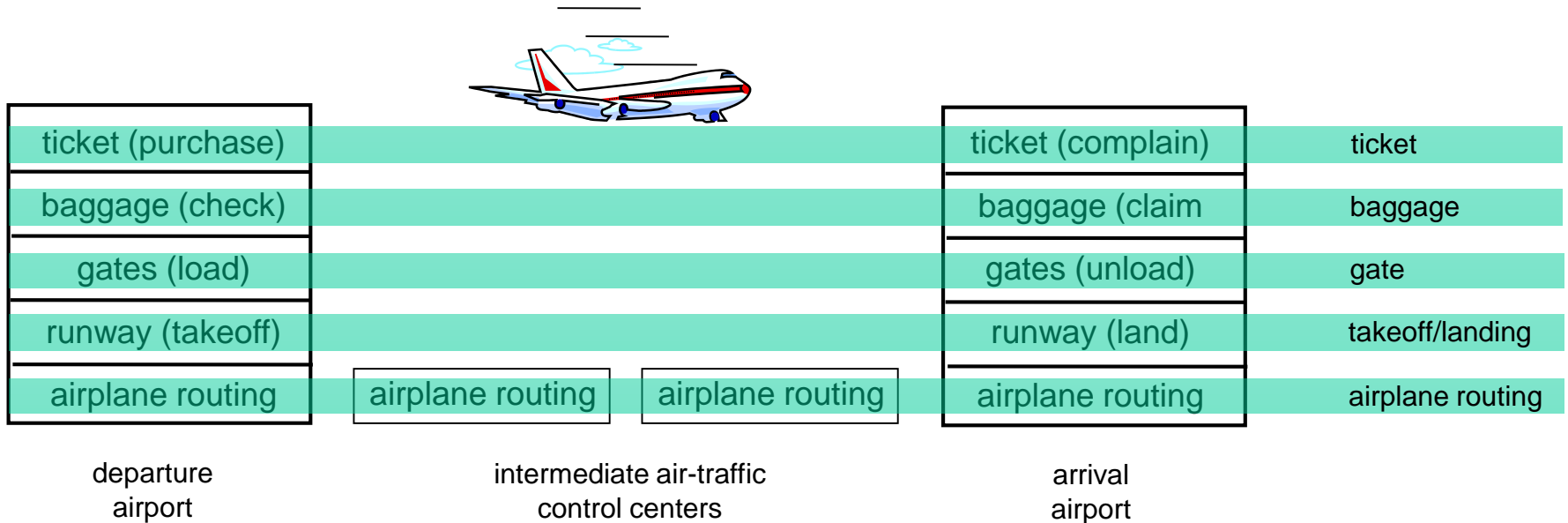

layers: each layer implements a service

- via its own internal-layer actions
- relying on services provided by layer below

Why layering?

dealing with complex systems:

- explicit structure allows identification, relationship of complex system's pieces
 - layered *reference model* for discussion
- modularization eases maintenance, updating of system
 - change of implementation of layer's service transparent to rest of system
 - e.g., change in gate procedure doesn't affect rest of system
- layering considered harmful?

Internet protocol stack

- **application:** supporting network applications
 - FTP, SMTP, HTTP
- **transport:** process-process data transfer
 - TCP, UDP
- **network:** routing of datagrams from source to destination
 - IP, routing protocols
- **link:** data transfer between neighboring network elements
 - Ethernet, 802.111 (WiFi), PPP
- **physical:** bits “on the wire”

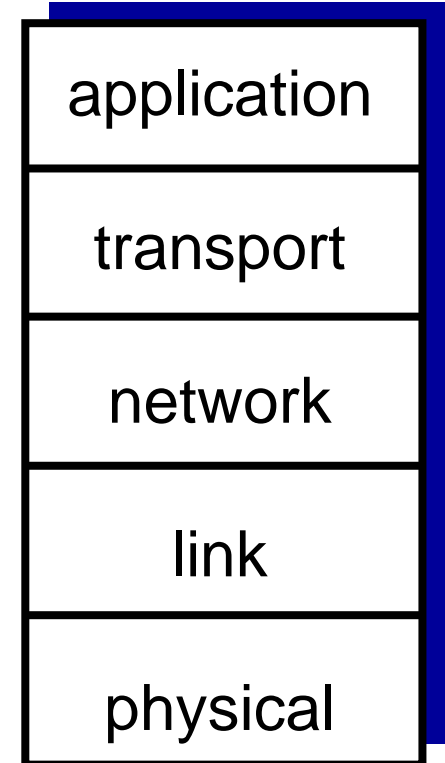

ISO/OSI reference model

- **presentation:** allow applications to interpret meaning of data, e.g., encryption, compression, machine-specific conventions
- **session:** synchronization, checkpointing, recovery of data exchange
- Internet stack “missing” these layers!
 - these services, *if needed*, must be implemented in application
 - needed?

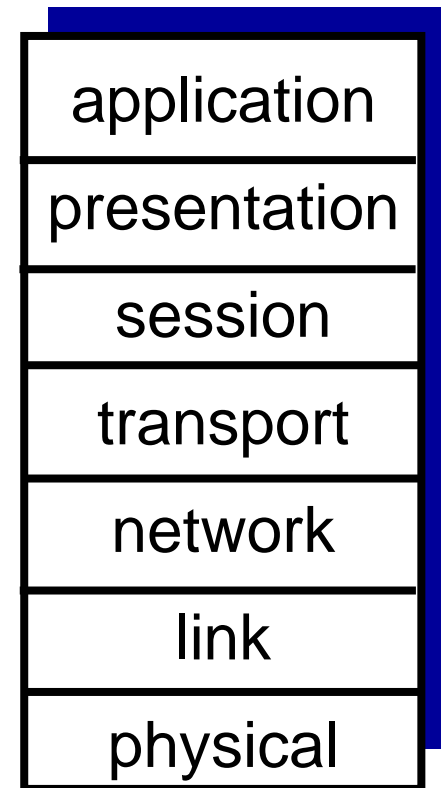

Encapsulation

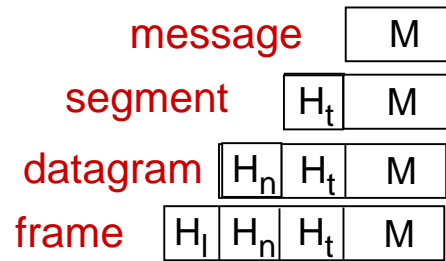

source

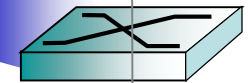
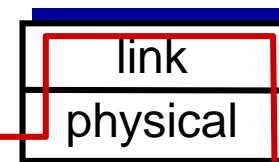
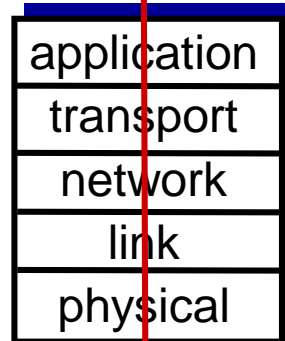

switch

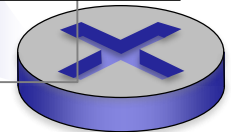
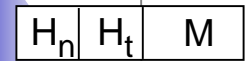
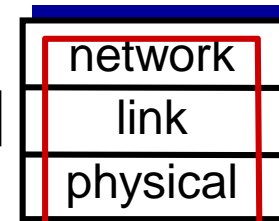

router

destination

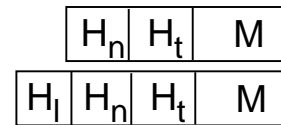
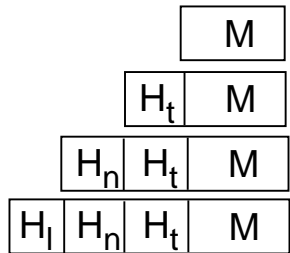
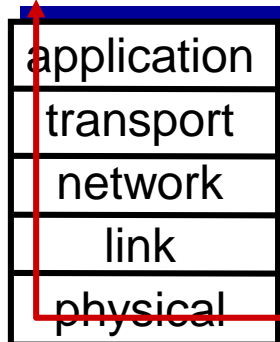

Chapter 1: roadmap

1.1 what *is* the Internet?

1.2 network edge

- end systems, access networks, links

1.3 network core

- packet switching, circuit switching, network structure

1.4 delay, loss, throughput in networks

1.5 protocol layers, service models

1.6 networks under attack: security

1.7 history

Network security

- **field of network security:**
 - how bad guys can attack computer networks
 - how we can defend networks against attacks
 - how to design architectures that are immune to attacks
- **Internet not originally designed with (much) security in mind**
 - *original vision:* “a group of mutually trusting users attached to a transparent network” 😊
 - Internet protocol designers playing “catch-up”
 - security considerations in all layers!

Bad guys: put malware into hosts via Internet

- malware can get in host from:
 - *virus*: self-replicating infection by receiving/executing object (e.g., e-mail attachment)
 - *worm*: self-replicating infection by passively receiving object that gets itself executed
- **spyware malware** can record keystrokes, web sites visited, upload info to collection site
- infected host can be enrolled in **botnet**, used for spam. DDoS attacks

Bad guys: attack server, network infrastructure

Denial of Service (DoS): attackers make resources (server, bandwidth) unavailable to legitimate traffic by overwhelming resource with bogus traffic

1. select target
2. break into hosts around the network (see botnet)
3. send packets to target from compromised hosts

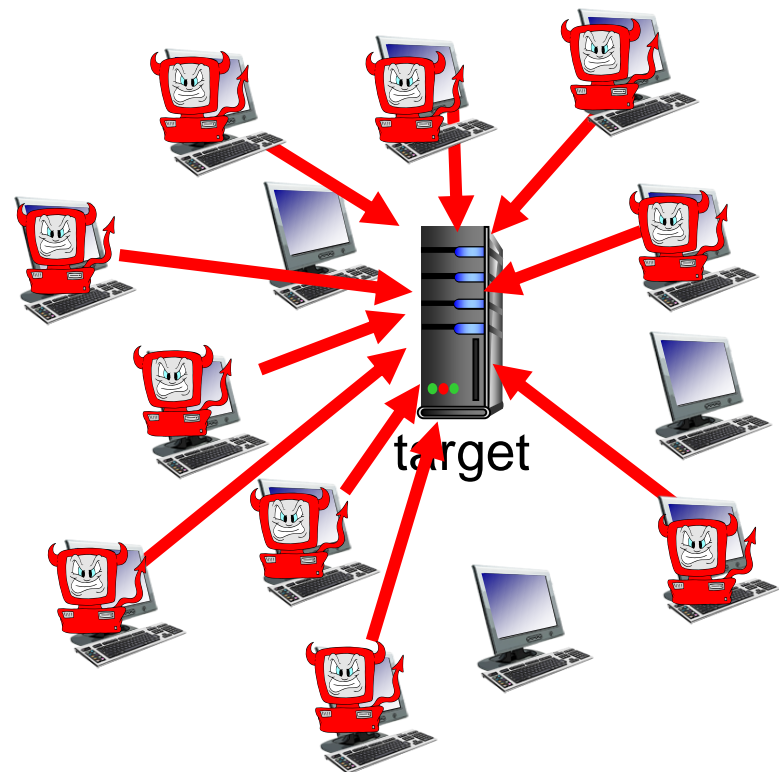

Bad guys can sniff packets

packet “sniffing”:

- broadcast media (shared Ethernet, wireless)
- promiscuous network interface reads/records all packets (e.g., including passwords!) passing by

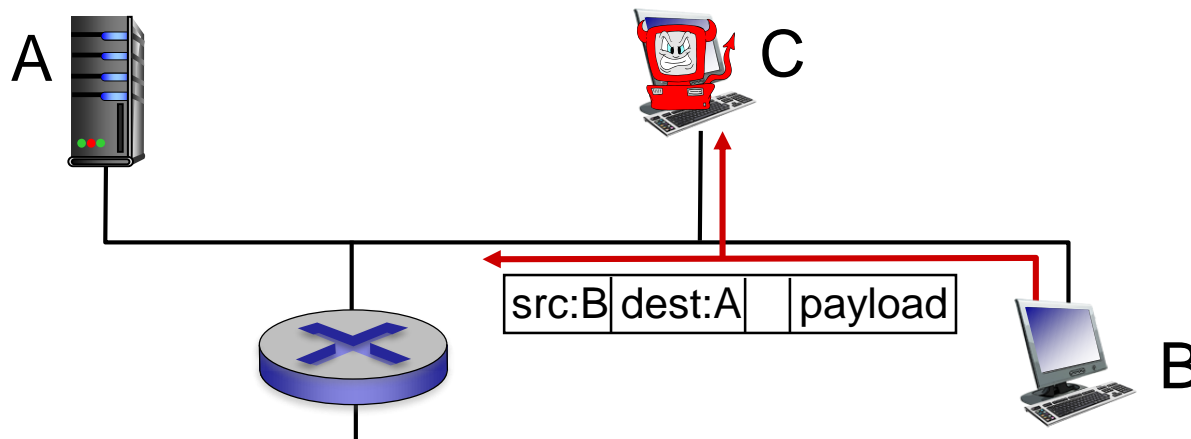

- wireshark software used for end-of-chapter labs is a (free) packet-sniffer

Bad guys can use fake addresses

IP spoofing: send packet with false source address

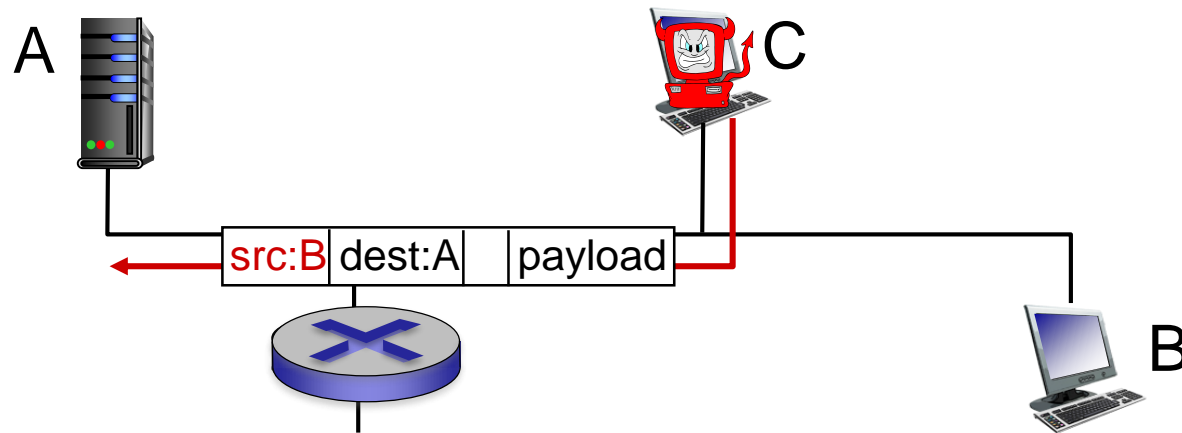

... lots more on security (throughout, Chapter 8)

Chapter 1: roadmap

1.1 what *is* the Internet?

1.2 network edge

- end systems, access networks, links

1.3 network core

- packet switching, circuit switching, network structure

1.4 delay, loss, throughput in networks

1.5 protocol layers, service models

1.6 networks under attack: security

1.7 **history**

Internet history

1961-1972: Early packet-switching principles

- **1961:** Kleinrock - queueing theory shows effectiveness of packet-switching
- **1964:** Baran - packet-switching in military nets
- **1967:** ARPANet conceived by Advanced Research Projects Agency
- **1969:** first ARPANet node operational
- **1972:**
 - ARPANet public demo
 - NCP (Network Control Protocol) first host-host protocol
 - first e-mail program
 - ARPANet has 15 nodes

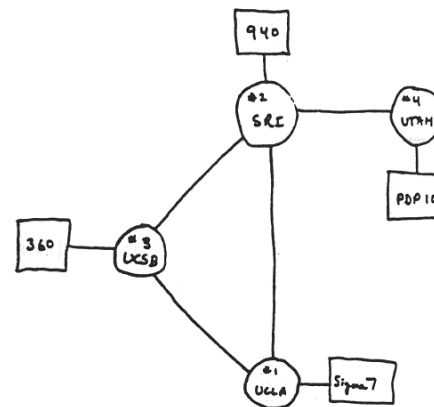

THE ARPA NETWORK

Internet history

1972-1980: Internetworking, new and proprietary nets

- **1970:** ALOHAnet satellite network in Hawaii
- **1974:** Cerf and Kahn - architecture for interconnecting networks
- **1976:** Ethernet at Xerox PARC
- **late70' s:** proprietary architectures: DECnet, SNA, XNA
- **late 70' s:** switching fixed length packets (ATM precursor)
- **1979:** ARPAnet has 200 nodes

Cerf and Kahn' s internetworking principles:

- minimalism, autonomy - no internal changes required to interconnect networks
- best effort service model
- stateless routers
- decentralized control

define today' s Internet
architecture

Internet history

1980-1990: new protocols, a proliferation of networks

- **1983:** deployment of TCP/IP
- **1982:** smtp e-mail protocol defined
- **1983:** DNS defined for name-to-IP-address translation
- **1985:** ftp protocol defined
- **1988:** TCP congestion control
- new national networks: CSnet, BITnet, NSFnet, Minitel
- 100,000 hosts connected to confederation of networks

Internet history

1990, 2000 's: commercialization, the Web, new apps

- early 1990' s: ARPAnet decommissioned
- 1991: NSF lifts restrictions on commercial use of NSFnet (decommissioned, 1995)
- early 1990s: Web
 - hypertext [Bush 1945, Nelson 1960' s]
 - HTML, HTTP: Berners-Lee
 - 1994: Mosaic, later Netscape
 - late 1990' s: commercialization of the Web
- late 1990' s – 2000' s:
 - more killer apps: instant messaging, P2P file sharing
 - network security to forefront
 - est. 50 million host, 100 million+ users
 - backbone links running at Gbps

Internet history

2005-present

- ~5B devices attached to Internet (2016)
 - smartphones and tablets
- aggressive deployment of broadband access
- increasing ubiquity of high-speed wireless access
- emergence of online social networks:
 - Facebook: ~ one billion users
- service providers (Google, Microsoft) create their own networks
 - bypass Internet, providing “instantaneous” access to search, video content, email, etc.
- e-commerce, universities, enterprises running their services in “cloud” (e.g., Amazon EC2)

Introduction: summary

covered a “ton” of material!

- Internet overview
- what’s a protocol?
- network edge, core, access network
 - packet-switching versus circuit-switching
 - Internet structure
- performance: loss, delay, throughput
- layering, service models
- security
- history

you now have:

- context, overview, “feel” of networking
- more depth, detail *to follow!*

Chapter I

Additional Slides

